

OPERATION AND PARTS MANUAL

STOW

Gasoline Crack Saw Model RCC130H

Revision #1 (11/18/04)

STOW
A DIVISION OF MULTIQUIP INC.

STOW CONSTRUCTION EQUIPMENT

A DIVISION OF MULTIQUIP INC.

POST OFFICE BOX 6254

CARSON, CA 90749

310-537-3700 • 888-252-STOW [888-252-7869]

FAX: 310-537-1986 • FAX: 800-556-1986

E-MAIL: stow@multiquip.com • WWW:

stowmfg.com

PARTS DEPARTMENT:

800-427-1244

FAX: 800-672-7877

SERVICE

DEPARTMENT/TECHNICAL

ASSISTANCE:

800-478-1244

FAX: 310-631-5032



WARNING



CALIFORNIA — Proposition 65 Warning

Engine exhaust and some of its constituents, and some dust created by power sanding, sawing, grinding, drilling and other construction activities contains chemicals known to the State of California to cause cancer, birth defects and other reproductive harm. Some examples of these chemicals are:

- Lead from lead-based paints.
- Crystalline silica from bricks.
- Cement and other masonry products.
- Arsenic and chromium from chemically treated lumber.

Your risk from these exposures varies, depending on how often you do this type of work. To reduce your exposure to these chemicals: **ALWAYS** work in a well ventilated area, and work with approved safety equipment, such as dust masks that are specially designed to filter out microscopic particles.

STOW CRACK SAW MODEL RCC130H

Table Of Contents.....	3-4
Parts Ordering Procedures	6
Notice to Operators.....	7-8
Operator Instructional Data Sheet	9
Safety Precautions.....	10
Preparation	11
Operation	12
Maintenance, Repair and Storage.....	13
Assembly	14
Removing the Crack Saw from the Pallet.....	14
Before Starting the Engine.....	14
Filling the Engine Crankcase with Oil.....	14
Filling the RCC130H Series Engine Fuel Tank	15
Operation	15
Theory of Operation.....	15
Information Relative to the use of Diamond Blades™	15-17
Installing a Diamond Blade™ on the Arbor Shaft.....	17
Transporting the Crack Saw	19-20
Starting the RCC130H Series Gasoline Powered Crack Saw On the Job Site.....	20
Operating the Crack Saw on the Job Site	21-29
Stopping the RCC130H Gasoline Powered Crack Saw	29
Operational Parameters and Techniques for RCC130H Series Crack Saw	29-30
Service/Maintenance	31
Preventative Maintenance Check List	31
Checking V-Belt Tension and Alignment.....	31
Installing a Replacement V-Belt or Pulley	32-34
Installing Replacement Bearings on the Arbor Shaft.....	34-37
Lubrication Requirements.....	37
Engine Service.....	38
Troubleshooting	39-41
Storage	42
Specifications.....	43
Explanation of Code In Remarks Column	44
Suggested Spare Parts.....	45

TABLE OF CONTENTS

Component Parts Drawings	
Operator Handle Assembly	46-47
Drivetrain Assembly	48-49
Frame Assembly	50-51
Dustpan/Vacuum Port Assembly	52-53
Wet Cutting Kit Assembly	54-55
Decals	56-57
Terms and Condition of Sale —Parts	58

PARTS ORDERING PROCEDURES

When ordering parts, please supply the following information:

- Dealer account number
- Dealer name and address
- Shipping address (if different than billing address)
- Return fax number
- Application Model number
- Quantity, part number and description of each part
- Specify preferred method of shipment:
 - ✓ FedEx or UPS Ground
 - ✓ FedEx or UPS Second Day or Third Day
 - ✓ FedEx or UPS Next Day
 - ✓ Federal Express Priority One
 - ✓ DHL
 - ✓ Truck

Note: Unless otherwise indicated by customer, all orders are treated as "Standard Orders", and will ship within 24 hours. We will make every effort to ship "Air Shipments" the same day that the order is received, if prior to 2PM west coast time. "Stock Orders" must be so noted on fax or web forms.



Here's how to get help...

Please have the model and serial number on hand when calling.

Parts Department

800-427-1244 Fax: 800-672-7877
310-537-3700 Fax: 310-637-3284

Service Department

800-478-1244 Fax: 310-537-4259
310-537-3700

Warranty Department

800-421-1244, Ext. 279 Fax: 310-537-1173
310-537-3700, Ext. 279

Sales Department

310-661-4242 Fax: 310-604-9237
877-289-7869 (877-BUY STOW)

Place Your Parts Order Via Web or Fax For Even More Savings!

Extra Discounts!

All parts orders which include complete part numbers and are received by our automated web parts order system, or by fax qualify for the following extra discounts:

Ordered via	Standard orders	Stock orders (\$750 list and above)
Fax	3%	10%
Web	5%	10%

Special freight allowances when you order 10 or more line items via Web or Fax! **

FedEx Ground Service *at no charge for freight*
No other allowances on freight shipped by any other carrier.

NOTE: DISCOUNTS ARE SUBJECT TO CHANGE



STOW CONSTRUCTION EQUIPMENT
A DIVISION OF MULTQUIP INC.
POST OFFICE BOX 6254
CARSON, CA 90749
310-537-3700 • 888-252-STOW [888-252-7869]
FAX: 310-537-1986 • FAX: 800-556-1986
E-MAIL: stow@multiquip.com • WWW: stowmfg.com

**Direct TOLL-FREE access
to our Parts Department:**
Toll-free nationwide — 800-427-1244

NOTICE TO OPERATORS

IF YOU CAN NOT READ OR DO NOT FULLY UNDERSTAND THE CONTENTS OF THIS MANUAL, PLEASE CONTACT THE FACTORY FOR PROPER ASSISTANCE BEFORE ATTEMPTING TO OPERATE THIS PRODUCT.

SI TU NO PUEDES LE'ER O NO COMPRENDES EL CONTENIDO DE ESTE MANUAL FAVOR DE PONERSE EN CONTACTO CON LA. FABRICA PARA ASISTENCIA- A PROPIA ANTES DE INTENTAR PARA OPERAR ESTE PRODUCTO.

SOLLTEN SIE DIESE GEBRAUCHSANWEISUNG NICHT LESEN KOENNEN ODER ES NICHT VOLLKOMMEN VERSTEHEN, WENDEN SIE SICH BITTE AN DEN HERSTELLER FUER RICHTIGE HILFE EHE SIE VERSUCHEN DIESES PRODUKT ZU OPERIEREN.

SI VOUS NE LISEZ OU NE COMPRENDRE ENTIEREMENT LES MATIERES DE CE MANUEL, S'IL VOUS PLAIT, CONTACTEZ L'USINE POUR L'ASSISTANCE APPROPRIEE AVANT D'UTILISER LE PRODUIT.

 DANGER

 CAUTION

These safety alert symbols identify important safety messages in this manual. When you see these symbols, be alert to the possibility of personal injury and carefully read the message that follows.

Do not allow anyone to operate the CRACK SAW without first reading this Operator Manual and becoming familiar with its operation. The manufacturer of the CRACK SAW has gone to great extremes to provide the owner(s) and/or operator(s) with the finest equipment available for its intended job function of removing covering materials from concrete and wood floor surfaces. Yet, the possibility exists that the CRACK SAW can be utilized in and/or subjected to job applications not perceived and/or anticipated by the manufacturer. Such misuse and/or misapplication of the CRACK SAW can lead to the possibility of serious damage, injury or even death. It is the responsibility of the owner(s) and/or operator(s) to determine that the CRACK SAW is being utilized and/or operated within the scope of its intended job function. It is the responsibility of the owner(s) and/or operator(s) to establish, monitor and constantly upgrade all safety programs and/or practices utilized in and for the operation of the CRACK SAW. The purpose of such programs is to provide for owner(s)' and/or operator(s)' safety. Operators must be instructed to recognize and avoid unsafe conditions associated with their work (29 CFR 1926.21 (b)(2)) and/or applicable updated revisions. It is the responsibility of the owner(s) and/or operator(s) to determine that no modifications and/or alterations have been made to the CRACK SAW. Modifications and/or alterations can lead to the possibility of serious damage, injury or even death. It is the responsibility of the owner(s) and/or operator(s) to make this Operator Manual available for consultation during all phases of operation. Refer to OSHA 2207 and/or applicable updated revisions which contains all OSHA job safety and health rules and regulations (1926 and 1910) covering construction.

⚠ CAUTION

The concept of frame mounted type Crack Saws has been successfully utilized for many years as a practical solution to many types of random crack sawing requirements. The basic concept is proven and well accepted within the associated marketplaces. Use of a Crack Saw requires strenuous work activity. This type of work activity can be considered to be greater in magnitude than that experienced with the use of many other types of both light construction and lawn and garden related equipment. This type of work activity should only be attempted by operators of adequate physical size and stature, mental awareness and physical strength and condition. The body parts most noticeably affected during the planing process are the arms, hands, wrists, shoulders, lower back and legs. The process can also produce excessive stress/strain directly to the back muscles, spinal vertebrae and many other body parts. Back related pain can be a side effect of utilizing a Crack Saw. An operator with a chronic back related problem or a history of back and/or other medically related problems should not attempt to utilize the Crack Saw. Use of the Crack Saw may only aggravate this and any other medically related problem. Because of the diverse type of prevailing job applications, job site conditions, operator experience levels and operator physical characteristics, no warranty, guarantee, representation and/or liability is made by the manufacturer as to the absolute correctness or sufficiency of any operational procedure, operational position and/or technique. There is no absolute guarantee that an operator of any given experience level, physical size and/or physical condition will be immune to the possibility of and/or probable physical side effects of the normal use of the Crack Saw. Each potential operator must be made aware of and assume the operational and physical liability described and/or associated with the use of the Crack Saw. Improper use of the Crack Saw can result in property damage and/or personal injury, including death. Each potential operator not willing to assume the operational and physical liability described and/or associated with the use of the Crack Saw, should not operate it. Proper levels of operator experience, skill and common sense are essential for maximizing the safe and efficient operation of the Crack Saw.

Record the CRACK SAW and electric motor serial numbers in the spaces provided below.

_____ Model Number

_____ Serial Number

_____ Date of Purchase

Specifications and design are subject to change without notice or obligation. All specifications are general in nature and are not intended for specific application purposes. STOW A Division of Multiquip reserves the right to make changes in design, engineering or specifications and to add improvements or discontinue manufacture at any time without notice or obligation. STOW and its agents accept no responsibility for variations which maybe evident in actual products, specifications, pictures and descriptions contained in this publication.

OPERATOR INSTRUCTIONAL DATA SHEET

The following undersigned operators of the RCC130H CRACK SAW described and/or pertaining to this Operator Manual have received formal safety and operational information/instruction from the undersigned owner(s)/instructor(s) in accordance to OSHA 29 CFR 1926.21 (b)(2) and/or applicable updated revisions pertaining to, but not necessarily limited to the:

1) READING, COMPREHENSION AND ACKNOWLEDGEMENT OF THE MATERIAL COMPRISING THE ENTIRE CONTENTS OF THE APPLICABLE OPERATOR MANUAL AND APPLICABLE SAFETY AND OPERATIONAL INFORMATION VIDEO TAPE FOR THE CRACK SAW.

2) FORMALIZED OPERATOR SAFETY PROGRAM TO BE DEvised BY THE OWNER OF THE CRACK SAW IN CONJUNCTION WITH THE CONTENTS OF THE APPLICABLE OPERATOR MANUAL AND THE APPLICABLE SAFETY AND OPERATIONAL INFORMATION VIDEO TAPE FOR THE CRACK SAW.

4) LOCAL LAWS, REGULATIONS AND CUSTOMS RESEARCHED FOR AND/OR BY THE OWNER OF THE CRACK SAW AND DEEMED APPLICABLE TO THE SAFE AND PROPER USE AND/OR OPERATION OF THE CRACK SAW FOR ANY SPECIFIC JOB APPLICATION.

5) FORMALIZED MAINTENANCE PROGRAM FOR THE CRACK SAW TO BE DEvised BY THE OWNER OF THE CRACK SAW IN ACCORDANCE WITH, BUT NOT NECESSARILY LIMITED TO, THE SPECIFICATIONS, GUIDELINES AND OPERATIONAL INFORMATION CONTAINED IN THE APPLICABLE OPERATOR MANUAL.

6) COMPREHENSIVE OPERATIONAL INSTRUCTIONS FOR THE CORRECT AND PROPER USE OF THE CRACK SAW AS PER THE CONTENTS OF THE APPLICABLE OPERATOR'S MANUAL, SAFETY AND OPERATIONAL INFORMATION VIDEO TAPE AND APPLICABLE MATERIAL INCLUDED IN THE NATIONAL ELECTRIC CODE®.

_____ Operator	_____ Owner/Instructor	_____ Date
_____ Operator	_____ Owner/Instructor	_____ Date
_____ Operator	_____ Owner/Instructor	_____ Date
_____ Operator	_____ Owner/Instructor	_____ Date
_____ Operator	_____ Owner/Instructor	_____ Date
_____ Operator	_____ Owner/Instructor	_____ Date

NOTE: INSERT COPIES OF THIS PAGE WITHIN THE OPERATOR'S MANUAL IF SPACE FOR ADDITIONAL OPERATORS IS REQUIRED.

DANGER

THE FOLLOWING SAFETY PRECAUTIONS PROVIDE SOME COMMON SENSE GUIDES TO PROMOTE SAFETY AND EFFICIENCY WITH THE CRACK SAW. NO WARRANTY, GUARANTEE OR REPRESENTATION IS MADE BY THE MANUFACTURER AS TO THE ABSOLUTE CORRECTNESS OR SUFFICIENCY OF ANY INFORMATION OR STATEMENT. THESE SAFETY PRECAUTIONS ARE INTENDED TO DEAL PRINCIPALLY WITH COMMON PRACTICES AND CONDITIONS ENCOUNTERED IN THE USE OF THE CRACK SAW AND ARE NOT INTENDED TO BE ALL INCLUSIVE. PROPER LEVELS OF OPERATOR EXPERIENCE, SKILL AND COMMON SENSE ARE ESSENTIAL FOR SAFE AND EFFICIENT OPERATION.

DANGER

THE ENGINE EXHAUST FROM THIS PRODUCT CONTAINS CHEMICALS KNOWN TO THE STATE OF CALIFORNIA TO CAUSE CANCER, BIRTH DEFECTS OR OTHER REPRODUCTIVE HARM. THIS STATEMENT IS MADE IN COMPLIANCE TO CALIFORNIA PROPOSITION 65..

DANGER

INCORRECT USE OF THE CRACK SAW CAN RESULT IN PROPERTY DAMAGE, PERSONAL INJURY OR EVEN DEATH. TO REDUCE THIS POSSIBILITY, GIVE COMPLETE AND UNDIVIDED ATTENTION TO THE JOB AT HAND AND FOLLOW THESE SAFETY PRECAUTIONS:

PREPARATION.

1) This Crack Saw is specialized type of powered equipment, designed for a specific job function and requires adequate and thorough instruction BEFORE it is operated. The size, power, complexity and operating characteristics of this type of powered equipment would dictate that each operator must receive adequate, professional instruction regarding the proper operation of this Crack Saw before being allowed to utilize it. BEFORE attempting to utilize this Crack Saw, read this Operator's Manual, the applicable Safety and Operational Information Video Tape and the material supplied by the engine manufacturer to familiarize each operator with its correct operating procedures. Avoid the urge not to

take the necessary time to read this Operator's Manual before operating the Crack Saw. DO NOT OPERATE THE CRACK SAW UNTIL EACH OPERATOR COMPLETELY COMPREHENDS THE CONTENTS OF THIS MANUAL AND THE APPLICABLE SAFETY AND OPERATIONAL INFORMATION VIDEO TAPE.

2) Develop a comprehensive program for the safe operation of the Crack Saw by its owner(s) and/or operator(s). Such a program will include, but is not limited to: instructional requirements for operation, applicable OSHA requirements, local laws and regulations, job site safety and a Crack Saw maintenance program. Constantly examine and upgrade this program to guarantee owner(s) and/or operator(s) safety. Each operator must be fully instructed regarding the specifics of this safety program.

3) Determine that the Crack Saw is in its original, factory configuration and has not been modified in any manner. Many modifications can result in potentially dangerous configurations that can lead to property damage and/or personal injury. If there are any questions about possible modifications made to the Crack Saw, contact the Customer Service Department for specific information BEFORE utilization. There is no charge for this service. Do not operate the Crack Saw without the use of the original equipment V-belt and diamond blade guards. Use of the Crack Saw without an approved belt guard and/or diamond blade guard can lead to property damage and/or personal injury.

4) Minors should never be allowed to operate the Crack Saw. Bystanders, especially children and animals, should not be allowed in the area where the Crack Saw is in use. The sawing process can result in flying particles being emitted at high velocity and striking the operator and/or onlookers. This can lead to the possibility of property damage and/or personal injury. Keep all body parts, loose clothing, foreign objects and onlookers clear of the rotating diamond blade, caster wheels, main wheels and flying particles.

5) Operators must be in adequate physical condition, mental health and not under the influence of any substance (drugs, alcohol, etc.) which might impair vision, dexterity or judgment. Working with the Crack Saw is strenuous. If you have any condition that might be aggravated by strenuous work, check with your doctor BEFORE operating the Crack Saw. Guard against the possibility of back related injuries. Always lift the Crack Saw with leg muscles and not with the back.

SAFETY PRECAUTIONS

6) Prolonged use of the CRACK SAW (or other, similar machines) exposes the operator to vibrations which may produce Whitefinger Disease (Raynaud's Phenomenon). This phenomenon reduces the hand's ability to feel and regulate temperature, produces numbness and burning sensations and may cause nerve and circulation damage and tissue necrosis. Antivibration systems do not guarantee that you will not sustain Whitefinger Disease. Therefore, continuous and regular users should closely monitor the condition of their hands and fingers. After each period of use, exercise to restore normal blood circulation. If any of the symptoms appear, seek medical advice immediately.

7) Clothing must be sturdy and snug fitting, but allow complete freedom of movement. Never wear loose fitting jackets, scarves, neckties, jewelry, flared or cuffed pants or anything that could become caught on controls or moving parts. Wear long pants to protect your legs. Protect your hands with heavy duty, nonslip gloves to improve your grip. Good footing is most important when operating the CRACK SAW. Wear sturdy boots with nonslip soles. Steel-toed safety shoes are highly recommended. Keep shoes properly laced. Never wear tennis shoes or other, similar type shoes which afford little or no protection. Wear an approved safety hard hat to protect the operator's head(s) where there is a danger of head injuries. Noise, generated by the operation of the CRACK SAW and the actual process itself, can damage your hearing. Wear approved sound barriers (ear plugs or ear muffers) to protect your hearing. Continuous and regular operators should have their hearing checked regularly.

8) Visually inspect the Crack Saw, components, tools and accessories for damaged or worn parts. BEFORE each use:

a) Disconnect the engine spark plug wire or power source cable.

b) Clean and remove all accumulated foreign matter from the wheels and determine that each rotates freely.

c) Clean and remove all accumulated foreign matter from inside the main frame area.

d) Inspect the V-belt drive for proper tension, wear and general condition. Replace each component as necessary.

e) Inspect the arbor shaft and diamond blade guard assemblies for excessive wear and structural

integrity. Replace each component as necessary. The arbor shaft rotates at high speed during the specific process and can be subject to high wear rates if the installed diamond blade is not properly maintained and/or replaced at regular service intervals.

f) Determine that operator controls work freely, all safety devices are operative and information decals are readable.

g) Check to see that the Crack Saw and all related accessories are in good, mechanical condition BEFORE utilization.

h) Reconnect the spark plug wire or power source cable as applicable

9) Contact appropriate representatives to determine if/where electrical cables, gas lines and other hazardous items are buried under the work surface BEFORE utilization. The Crack Saw and related accessories are not insulated. Contact with buried electrical cables, gas lines and other hazardous items can result in electrocution and/or an explosion.

10) Know how the controls operate. Know how to stop the engine or electrical motor quickly in an emergency. Always start the engine or electric motor according to the instructions as outlined in this manual to minimize the possibility of unexpected contact with the work surface. Unexpected contact with the work surface can cause loss of machine control, and the possibility of property damage and/or personal injury.

11) Never exceed the recommended capacities of the Crack Saw. Refer to the **Specifications** section of this manual for more detailed information.

SAFETY PRECAUTIONS

OPERATION.

1) Give complete and undivided attention to the job at hand. Do not chew gum, smoke and/or use smokeless tobacco while utilizing the Crack Saw. Do not attempt to eat and/or drink while utilizing the Crack Saw. Determine that eyeglasses and/or hearing aid devices are properly secured

Use of the Crack Saw is strenuous and causes fatigue. Help prevent the cause of an accident. Plan to take work breaks as required to help maintain proper mental and physical alertness.

2) This CRACK SAW is not sealed or insulated. Do not operate the CRACK SAW in an explosive atmosphere or near combustible materials. Refer to current OSHA® rules and regulations.

3) Gasoline is an extremely flammable fuel. Use extreme caution when handling gasoline or mixing fuel. Always utilize UL®, CSA® OR CE approved containers for the storage and transportation of fuel. Do not smoke or bring fire or flame near the fuel. Always shut off the engine and allow it to cool before refueling. Never remove the fuel tank filler cap while the engine is running. Never operate an engine without a fuel tank filler cap. Select bare ground for fueling and move at least 10 feet from the fueling spot before starting the engine. Wipe off any spilled fuel before starting the engine and check for leakage. If a fuel or oil leak is found, do not start or run the engine until the leak is fixed and the spillage has been wiped away. Take care not to get fuel or oil on your clothing. If this happens, change your clothing immediately. Before operating the Crack Saw refer to the **Specifications** section of this manual for more detailed information regarding fuel and lubrication requirements.

4) The Crack Saw is designed for use by one operator. Use of the Crack Saw by more than one operator can lead to confusion and loss of control, resulting in property damage and/or personal injury. If it is felt that more than one person is required to operate the Crack Saw, STOP and contact the Customer Service Department for specific operational and service/maintenance information. There is no charge for this service.

5) Do not operate the Crack Saw with onlookers close by. Caution all onlookers to stand clear. The sawing process can result in flying particles being emitted at high velocity and striking the operator and/or onlookers. This can lead to the possibility of property damage and/or personal injury. Keep all body parts, loose clothing and foreign objects clear of the rotating diamond blade.

6) Start the engine or electric motor according to the instructions as outlined in this manual to minimize the possibility of unexpected contact with the work surface. Unexpected contact with the work surface can cause the loss of machine control and the possibility of property damage and/or personal injury.

7) Start and operate the Crack Saw only in a well ventilated area. Carbon Monoxide fumes given off by an engine are poisonous. Breathing these fumes can result in property damage and/or personal injury. Operate the Crack Saw only when/where visibility and light are adequate for the job at hand. Work carefully. Always hold the operator handle firmly with both hands. Wrap your fingers around the handle, keeping it cradled between your thumbs and fingers. Always make sure the operator handle is in good condition and free of moisture, pitch, oil or grease. Wear gloves to improve your grip. Never leave the Crack Saw running unattended.

8) Special care must be exercised on slippery conditions and on difficult, uneven surfaces. Watch for cracks, high spots and other, surface irregularities. Keep proper footing and balance at all times. The normal use of this machine is on level surfaces. Other terrains can be dangerous and should be avoided. Only properly trained operators should attempt these techniques.

9) Never start the engine or electric motor with the Crack Saw directly over cracked, uneven or irregular surfaces. Start the engine or electric motor according to the instructions as outlined in this manual.

10) Contact with a hot, engine muffler can cause property damage and/or personal injury. Remain clear of a hot, engine muffler. Do not over speed the engine by altering the governor setting or by disconnecting the engine governor. Serious damage to the engine and/or personal injury can result.

11) Clean and remove all accumulated foreign matter from inside the main frame area after each use. This practice will maximize bearing and V-belt service life.

12) Because this Crack Saw is classified as a low cost, hand held, low horsepower, portable type machine, it is limited in the number of practical and/or suitable job applications. A particular job site, actual surface conditions, job specifications and operator skill/common sense may dictate that a different type of machine (with characteristics of higher purchase cost, being mounted to a carrier

SAFETY PRECAUTIONS

vehicle, with greater horsepower and less mobility), method and/or process be utilized to properly complete the job with the degree of efficiency and safety required. Contact the Customer Service Department for specific information regarding suitable job applications, job sites surface conditions and operator experience/skill/common sense recommendations for this Crack Saw BEFORE utilization. There is no charge for this service.

MAINTENANCE, REPAIR AND STORAGE.

1) Use only genuine, approved replacement parts and accessories for maintenance and repair. Use of parts and accessories manufactured by others can result in property damage and/or personal injury.

2) Follow the **Service** instructions as outlined in the appropriate section of this manual.

3) Always stop the engine or electric motor and disconnect the spark plug wire or power source cable BEFORE checking or working on the Crack Saw.

4) Always properly maintain the Crack Saw. Frequently check all fasteners and individual parts. Built in safety features are effective only if they are maintained in good working condition. Replace any questionable part or assembly with a genuine, factory approved, replacement part. Do not forsake proper maintenance for the price of a few replacement parts. Proper maintenance does not cost...it actually pays dividends. Do not attempt any maintenance repair work not described in this manual. Have such work performed at your dealer's service facility.

5) A worn or damaged engine muffler is a fire hazard and may cause loss of hearing. Check to see that the muffler is in good condition. If the muffler is equipped with a spark arresting device, determine that it is in proper working condition at regular service intervals. Replace the spark arresting device with an approved replacement if there is any question of its integrity. It is the responsibility of the owner(s) and/or operator(s) to provide for and properly maintain a USDA approved, spark arresting muffler in an operating area specified by law. Check with appropriate governing agencies for more specific information. The Crack Saw must not be operated if the muffler is faulty or has been removed. Contact with a hot engine muffler can cause property damage and/or personal injury.

6) Do not operate the Crack Saw without the use of factory approved V-belt and diamond blade guards that are maintained in proper structural condition.

Frequently inspect the guards for signs of wear, cracks and other signs of fatigue. If there is any question regarding the structural integrity and/or condition of the belt guard, properly dispose and replace with a genuine, factory approved, replacement part only.

7) Maintain all safety and operation decals in proper condition. If any decal becomes damaged and/or unreadable, replace with a genuine, factory approved, replacement part only.

8) The Crack Saw utilizes many self locking type hexagon head nuts to minimize the effects of vibration. Replace all self locking hardware with genuine, factory approved, replacement parts only.

9) Consult the material supplied by the engine or electric motor manufacturer for specific information relative to proper operational, lubrication and storage requirements.

Assembly

The RCC130H Crack Saw is shipped from the factory secured on a specially designed wooden pallet and protected from external damage by a corrugated carton or wood crate. If shipped with a corrugated carton, the Crack Saw can be secured to the pallet by wood laths nailed to the pallet body. Remove the carton or crate immediately upon receipt using suitable tools to remove the nails.

REMOVING THE CRACK SAW FROM THE PALLET.

Tools Required:

1 each, pliers.

1 each, claw hammer or a hammer and an appropriate pry bar.

The Crack Saw is secured to the pallet with steel banding. Using the pliers, cut and remove the banding. The Crack Saw can then be removed from the pallet.

DANGER

WEAR SAFETY GLASSES AND OTHER APPROPRIATE SAFETY APPAREL WHEN CUTTING THE STEEL BANDING AND/OR REMOVING THE CORRUGATED/WOOD SHIPPING CRATE.

Visually inspect the shipment for freight damage and/or missing parts. If shipping damage is evident, contact the delivering carrier immediately to arrange for an inspection of the damage by their claims representative. Federal law requires that a claim be filed within a specific time period. If missing parts are detected, notify your dealer who will assist you in obtaining them.

The Crack Saw is shipped from the factory completely assembled. If ordered with the Crack Saw, attachments or accessories are normally shipped separately to minimize the potential for loss during shipment.

Check all fasteners for proper security. Consult a fastener torque chart for the proper torque value if any fastener is found to require retorquing.

Before Starting the Engine

FILLING THE ENGINE CRANKCASE WITH OIL.

Note: The RCC130H Crack Saw is shipped with oil in the engine crankcase. Fuel is drained from the fuel tank and will be marked accordingly by factory personnel.

Tools Required:

1 each, small, clean funnel.

The RCC130H Series Crack Saw comes equipped with a Honda 13 HP gasoline engine. The engine is not normally pre-serviced at the factory (see note above) and will require the addition of oil in the crankcase before being placed in service. Consult the material supplied by the engine manufacturer for the engine that has been ordered with your Crack Saw. Carefully review this material to become familiar with specific operating characteristics, recommendations and service requirements.

1) Determine the location(s) of both the oil filler and oil drain plug(s).

2) Wipe oil, dust and accumulated dirt from the filler plug area.

3) Using the funnel, fill the engine crankcase with a high grade motor oil. Consult the material supplied by the engine manufacturer for proper amount, weight and service classification.

4) Replace the oil filler plug and tighten. Wipe off any excess oil spilled on the engine crankcase and Crack Saw.

5) Do not operate the engine unless proper oil level is maintained as per the material supplied by the engine manufacturer.

FILLING THE RCC130H FUEL TANK.

Tools Required:

1 each, small, clean funnel.

CAUTION

Never mix oil with gasoline. Four cycle engines are not designed to be operated with oil mixed with the gasoline.

ASSEMBLY INSTRUCTIONS/OPERATIONS

- 1) Determine the location of the fuel tank filler cap.
- 2) Carefully clean the filler cap and surrounding area to insure that no dirt or debris falls into the fuel tank. Remove the filler cap.
- 3) Using the funnel, fill the fuel tank with fresh, clean fuel according to the specifications outlined in the material supplied by the engine manufacturer. Do not overfill the tank or spill any fuel. If the fuel tank incorporates a screen mesh to prevent debris from falling into the tank, do not remove to increase the fill rate. Replace the filler cap. Wipe away any excess spilled fuel.

! DANGER

MANY FUELS ARE EXTREMELY FLAMMABLE. DO NOT SMOKE NEAR THE FUEL TANK. DO NOT FILL THE FUEL TANK WITH THE ENGINE RUNNING OR IF IT IS HOT. ALLOW AMPLE TIME BETWEEN EACH REFUELING FOR THE ENGINE TO COOL.

Operation

THEORY OF OPERATION.

The RCC130H Crack Saw operates on the principle of transmitting horsepower through a V-Belt transmission directly to an industry standard, 8 inch diameter, diamond segment blade of various widths.

The crack sawing process is directly controlled by these conditions:

- a) The use of a suitable mechanism (diamond blade) of proper design and configuration to penetrate the work surface and remove material while delivering acceptable service life.
- b) Sufficient static weight supporting the diamond blade to allow it to effectively penetrate the work surface and remove material.
- c) Adequate horsepower capable of rotating the diamond blade at industry recognized speeds against the work surface to deliver acceptable productivity rates.

Since no two materials are exactly alike, no two work surface materials can be sawed by the exact same method. The nature of the sawing process, along with operator experience, skill and common sense, would suggest that efficient and productive crack sawing is a matter of trial and error. Combinations of diamond blade type, condition, and

feed rate are direct factors that will also determine the overall success of the job application.

INFORMATION RELATIVE TO THE USE OF DIAMOND BLADES.

Safety requirements always override performance considerations. Diamond blade technology has made such rapid advances during the past few years that a diamond blade, properly used, on well designed and well maintained equipment, can provide the lowest cost per cut of any of the methods of cutting now in use. But, put that same blade onto a piece of poorly maintained equipment and in the hands of a poorly trained operator and the cost of cutting can virtually put you out of business.

The members of the Saw Manufacturer's Institute have been a significant contributor to the state of the diamond blade art. We hope that some of the knowledge and experience that we have accumulated in our many years in the business can, through this booklet, assist you in keeping your cost down to an absolute minimum.

Of all the problems that confront diamond blade users, blade wear is the most difficult to accurately evaluate. Reporting life performance of identical diamond blade specifications operating under seemingly identical conditions tend to be inconsistent.

Masonry blade operators frequently report blade life in terms of hours, days or weeks. However, these reports neglect to mention type of material being cut, the size of the cuts, and the number of cuts per day. In addition, the amount and the cleanliness of the water and the amount of pressure the operator applies to the cut have an effect on blade life.

Obviously, trying to compare the life of one diamond blade with another, simply on the basis of hours, is analogous to trying to compare a set of tires on one car with an identical set on another car...it is virtually impossible. There are just too many variables...the weight of the car, the types of roads driven on, the condition of the car...particularly the suspension, the manner in which the operator handles the car, etc. Just as many variables apply to diamond blades.

So, the next time you have reason to compare blade life, keep these variables in mind. Some of the problems arising from these variables can be quickly identified, and possibly corrected"...

Excerpt from: Rx for Diamond Blades, Problems, Causes, Effects, Remedies, published by the Masonry and Concrete Manufacturers Institute.

! DANGER

IMPROPER USE OF A DIAMOND BLADE WITH THE CRACK SAW CAN RESULT IN PROPERTY DAMAGE AND/OR PERSONAL INJURY.

! DANGER

PROPER OPERATIONAL USE OF A DIAMOND BLADE THAT DOES NOT MEET INDUSTRY SPECIFICATIONS AND/OR SAFETY STANDARDS WITH THE CRACK SAW CAN RESULT IN PROPERTY DAMAGE AND/OR PERSONAL INJURY.

General Information.

1) " Only mature, properly instructed adults should be permitted to operate machinery and tools.

2) Only utilize the blade to cut the material it is designed and intended to cut. Blades intended for masonry material (stone, concrete bricks, blocks) or blades for steel or ductile iron must only be used in those materials. If you need to cut a material other than the ones listed above, you must use a blade that has been designed for that specific material. Use of a blade in the wrong material may involve a considerable safety risk. It may also reduce the life of the blade or damage the blade.

3) Inspect all diamond blades for damage before use.

4) Never use a new or used diamond blade that shows damage such as cracks, missing segments, damage to the arbor hole or by the flange washers, or other appearances not consistent with the appearance of a new blade. These are indications of previous improper use. If you have any doubt about the safety of a blade, contact the Customer Service Department of the blade manufacturer for assistance. If you do not know the name of the blade manufacturer, contact the Customer Service Department of General Equipment Company for assistance. There is no charge for this service.

5) Always check that the two mounting flanges are of the same diameter and that they are clean and flat. The flanges should not have any cracks or show any abnormal wear. Make sure that the arbor bolt or nut is the correct one for the equipment without damage to the threads. Improper or damaged flange washers and/or damaged fasteners can damage the

blade or cause the blade to come loose from its mount. A blade that comes loose can cause serious bodily injury or death to the operator or bystander. If there are any questions regarding the suitability of a specific mounting flange, contact the Customer Service Department for assistance BEFORE utilizing the diamond blade. There is no charge for this service.

6) Always make sure that the arbor hole in the blade matches the one on the equipment. Do not force the blade onto the spindle. Do not use an arbor shaft (spindle) and blade combination of different sizes. Proper fit is achieved when the blade slides onto the arbor without having more than 0.1 mm (0.005 inch) radial play.

7) Always tighten the bolt or nut for the flange washers in accordance with the equipment manufacturer's specifications.

8) Always make sure that the equipment used is in good operating condition in accordance with the manufacturer's specifications. Do not operate the equipment unless the guards are in good condition, in the proper place and secure. If the equipment appears to be missing any fasteners or has any parts that appear loose or worn, do not operate the equipment until the appropriate repairs are performed. Always make sure the blade you intend to use with the equipment meets all the equipment manufacturer's specifications.

9) Do not operate the equipment with other than the recommended blade sizes. This can result in severe blade damage. Contact the machine manufacturer for advice.

10) Make sure that the spindle speed on the machine does not exceed the **maximum RPM** indicated on the diamond blade. This can result in blade breakage. Check the blade shaft with a tachometer to verify that the equipment's maximum RPM does not exceed the manufacturer's specifications.

11) Blades designed for wet cutting must be cooled by an adequate, continuous water flow to each side of the blade. Lack of enough coolant will cause excessive heat, poor blade performance and possible segment loss.

12) Blades designed for dry cutting may be used without water coolant. However, dry cutting blades can overheat which will result in loss of blade tension and may ruin the blade. The risk is greatest during long continuous cutting. Most overheating problems can be avoided by lifting the blade out of

ASSEMBLY INSTRUCTIONS/OPERATIONS

the cut and letting it cool by rotating in the air for 15 to 20 seconds after every one minute of cutting.

13) Do not force the tool into the material to be cut. A properly working diamond tool will grind the material without excessive force being applied. If excessive force is needed, it indicates there is damage to the blade to the blade or the wrong blade is being used.

14) Always inspect the diamond blade and the equipment any time you stop during the cut. If you notice any difference in performance as your work progresses, immediately **STOP** and inspect the equipment and the diamond tool.

15) Do not operate any diamond tool without full knowledge about appropriate cooling of the tool. If a tool is not cooled properly, the blade core can become damaged resulting in the segments coming loose or the blade core (the steel) breaking. **This can result in serious bodily injury or death to the operator or bystander.**

16) Do not allow any bystanders in the work area. Never allow anyone to stand in front of a saw that is about to be started or is running.

Standards.

The manufacturing of machinery and grinding wheels and the usage of these products are covered in several OSHA and ANSI standards. The most applicable standard for these products is ANSI B7.1 and B7.5. Copies of these standards can be obtained from the American National Standards Institute, 1430 Broadway, New York, NY 10018.

Personal Safety Equipment.

- 1) Always wear dust masks (respirators) approved for use in concrete and stone dust.
- 2) Always wear approved eye protection such as goggles or face shield.
- 3) Always wear approved hearing protection.
- 4) Always wear approved head protection.
- 5) Always wear approved safety footwear.
- 6) Always wear approved gloves.

Note.

In the manufacturing of all diamond blades different metals are used such as Boron, Copper, Colbalt,

Nickel, Iron, Tungsten, Molybdenum, Tin, etc., as outlined in the Material Safety Data Sheet (MSDS). This product as sold presents no hazard although, during use, small amounts of these metal substances may be released into the dust or slurry generated from the material being cut or ground. Prolonged exposure to excessive amounts of dust and slurry may cause respiratory disease, skin irritation or cancer.

Common Sense.

Almost all accidents are avoidable if you apply caution and common sense. Follow all safety precautions at all times. If you are not sure...simply don't do it. Ask for advice. Used improperly or carelessly any tool is dangerous and may cause severe bodily injury or death. If tools are used with caution, proper techniques and common sense, they will do an excellent job for you"...

Excerpt from: Instructions for the Safe Use of Diamond Tools, published by Dimas Industries.

INSTALLING A DIAMOND BLADE ON THE ARBOR SHAFT.

Tools required:

1 each, 3/4 inch wrench.

1 each, PN CS8-0400 1-1/2 inch wrench or equivalent.

DANGER

WHEN INSTALLING A DIAMOND BLADE ON THE ARBOR SHAFT ALWAYS WEAR THE APPROPRIATE SAFETY EYEWEAR AND APPAREL TO MINIMIZE THE POTENTIAL FROM FLYING DEBRIS. FLYING DEBRIS CAN RESULT IN PROPERTY DAMAGE AND/OR PERSONAL INJURY.

- 1) Disconnect the spark plug wire.
- 2) Rotate the height adjustment lever counterclockwise to raise the blade to its maximum position above the work surface. FIGURE 1.

ASSEMBLY INSTRUCTIONS/OPERATIONS

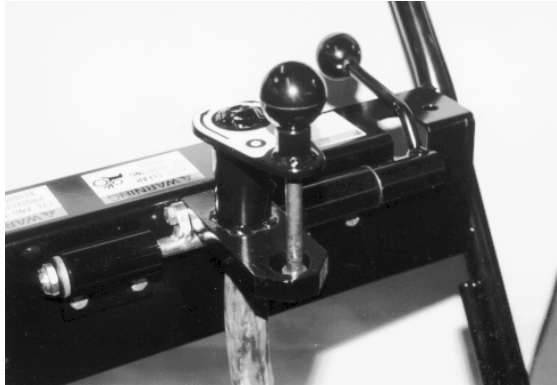

FIGURE 1

3) Position the quick change height lever over center to its rear most (up) position. FIGURE 2.



FIGURE 2

⚠ DANGER

IMPROPER BLADE POSITION DURING THE STARTING PROCEDURE CAN ALLOW THE BLADE TO CONTACT THE WORK SURFACE BEFORE THE OPERATOR CAN ASSUME A PROPER OPERATING POSITION. THIS OCCURRENCE CAN RESULT IN PROPERTY DAMAGE AND/OR PERSONAL INJURY.

4) Remove the blade guard from the main frame with the 3/4 inch wrench to expose the arbor shaft. Using the 1-1/2 inch wrench, remove the hexagon nut and hub flange from the shaft. The arbor shaft incorporates left hand threads. FIGURE 3.

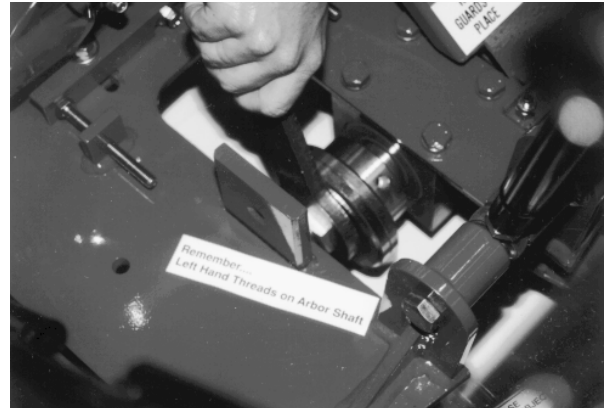

FIGURE 3

5) Inspect the hub flange, hub body and arbor shaft for proper structural integrity. Determine that all components are free from surface imperfections including, but not limited to corrosion, cracks, warpage and material build-ups. Remove any material build-up from the mating surfaces of the hub components. Replace any questionable component with a factory approved replacement part only. If there are any questions regarding the suitability of a specific component, contact the Customer Service Department for assistance BEFORE utilizing the Crack Saw. There is no charge for this service. FIGURE 4.

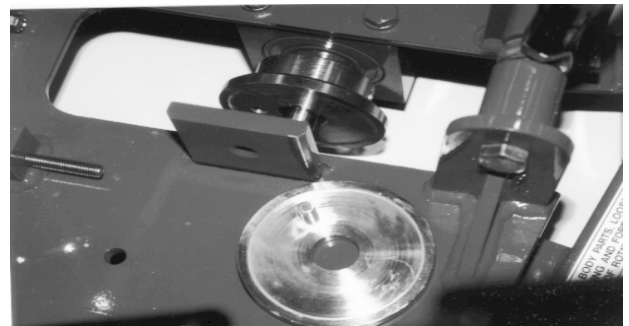

FIGURE 4

6) Inspect the diamond blade for proper structural integrity as outlined above. If there are any questions regarding the suitability of a diamond blade, contact the specific manufacturer or the Customer Service Department of General Equipment Company for assistance BEFORE utilizing it with the Crack Saw. There is no charge for contacting the Customer Service Department of General Equipment Company.

7) Proper blade rotation direction is marked on the side of the blade blank. The Crack Saw is of a down cut type design as viewed by the operator. The diamond blade is intended rotate toward the operator to enhance visibility and overall productivity

ASSEMBLY INSTRUCTIONS/OPERATIONS

while following a random crack. Determine the correct rotation orientation for the diamond blade and install it on the arbor shaft. FIGURE 5.

8) Reinstall the hub flange on the arbor shaft and align the stud directly with the corresponding hole in the blade blank and hub body. The stud is not designed to drive the diamond blade. FIGURE 6.

! DANGER

DO NOT UTILIZE A DIAMOND BLADE THAT DOES NOT INCORPORATE A DRIVE HOLE FOR THE HUB FLANGE STUD. DO NOT UTILIZE A DIAMOND BLADE THAT HAS AN EXCESSIVELY WORN DRIVE HOLE. DO NOT OPERATE THE CRACK SAW WITH THE HUB FLANGE REVERSED FROM ITS NORMAL OPERATING CONFIGURATION TO ENABLE THE USE OF A DIAMOND BLADE WITHOUT A DRIVE HOLE. THE RESULT CAN BE PROPERTY DAMAGE AND/OR PERSONAL INJURY.



FIGURE 5

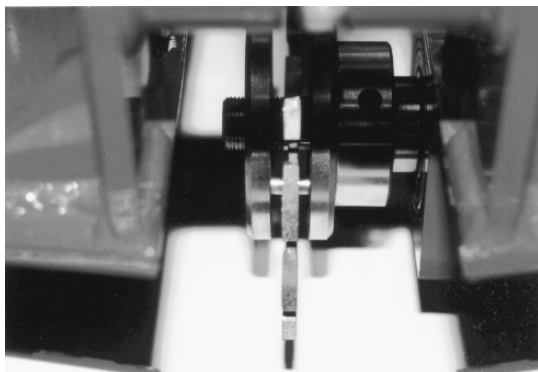

FIGURE 6

9) Reinstall the hexagon nut and tighten with the wrench until the hub flange and body components exert consistent, firm clamping pressure against the blade blank. The arbor shaft incorporates left hand threads, making the hexagon nut semi self-tightening against the hub and blade.

10) Reinstall and tighten the Blade Guard to the main frame.

! DANGER

DO NOT OPERATE THE CRACK SAW WITHOUT THE BLADE GUARD PROPERLY INSTALLED. OPERATION OF THE CRACK SAW WITHOUT THE BLADE GUARD PROPERLY INSTALLED CAN RESULT IN PROPERTY DAMAGE AND/OR PERSONAL INJURY.

11) Reconnect the engine spark plug wire.

! DANGER

UNEXPECTED MACHINE START UP CAN RESULT IN PROPERTY DAMAGE AND/OR PERSONAL INJURY.

12) To remove the diamond blade from the arbor shaft, reverse the steps as outlined above.

TRANSPORTING THE CRACK SAW.

Application: All Models.

The Crack Saw has an operational weight that prohibits one person from loading and/or unloading it alone by conventional, physical efforts.

! DANGER

DO NOT ATTEMPT TO LIFT THE CRACK SAW UP INTO A TRANSPORTATION VEHICLE WITH THE USE OF ONE PERSON ALONE. DO NOT ATTEMPT TO LOWER THE CRACK SAW FROM A TRANSPORTATION VEHICLE WITH THE USE OF ONE PERSON ALONE. LIFT AND/OR LOWER THE CRACK SAW ONLY BY THE USE OF A POWER TAILGATE UNIT, A SUITABLE HOIST UNIT OF PROPER CAPACITY AND/OR CONFIGURATION OR BY THE USE OF A

ASSEMBLY INSTRUCTIONS/OPERATIONS

PROPER QUANTITY OF PERSONNEL IN PROPER PHYSICAL CONDITION.

The integral lifting bail device(s) can be used to facilitate lifting by a mechanical device incorporating a chain and suitable attachment device. The location of the lifting bail(s) may not always locate the exact position of the center of gravity for the Crack Saw.

Typical Hoisting Configuration

FIGURE 7 depicts a typical hoisting configuration for a Crack Saw with a mechanical lifting device.

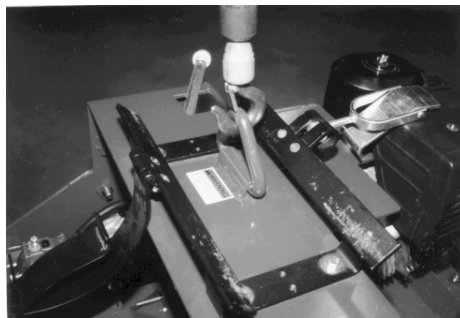

FIGURE 10

! DANGER

EXERCISE EXTREME CAUTION WHEN UTILIZING A MECHANICAL DEVICE FOR LIFTING THE CRACK SAW. UTILIZE THE MECHANICAL DEVICE IN ACCORDANCE TO BOTH ITS STATED STATIC AND DYNAMIC LOADING ENVELOPES. DO NOT UTILIZE THE MECHANICAL DEVICE UNTIL THIS INFORMATION IS PROPERLY KNOWN AND UNDERSTOOD BY ALL APPLICABLE PERSONNEL. FAILURE TO PROPERLY UTILIZE THE MECHANICAL DEVICE CAN RESULT IN PROPERTY DAMAGE AND/OR PERSONAL INJURY.

8) Once on the job site, the Crack Saw can be lowered to the work surface by reversing the above steps.

General Transportation Information.

When transporting the Crack Saw on a motor vehicle, the fuel tank breather vent (if so equipped) must be completely closed to eliminate the accidental seepage of fuel and resulting potential fire and environmental hazards. To minimize the possibility of damage to the Crack Saw, always transport in its normal, upright position. All equipment must be secured in/on vehicles with suitable strapping or tie-downs. Personnel should not be transported in the same compartment as equipment and fuel supplies. Consult applicable

OSHA, AGA, CGA, etc. regulations for the proper transportation of flammable gases.

STARTING THE RCC130H SERIES GASOLINE POWERED CRACK SAW ON THE JOB SITE.

- 1) Position the Crack Saw on a flat and level surface of firm foundation.
- 2) Rotate the height adjustment lever counterclockwise to raise the blade to its maximum position above the work surface. FIGURE 15.

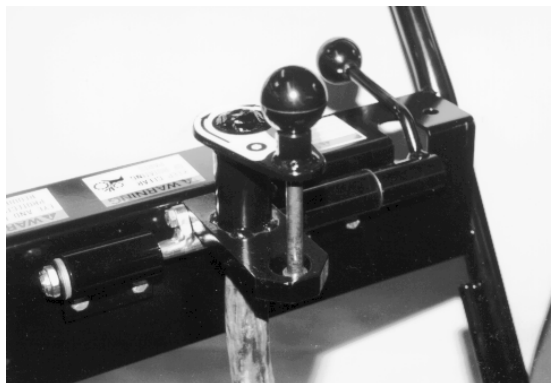

FIGURE 15

- 3) Position the quick-change height lever over center to its rear most (up) position. FIGURE 16.



FIGURE 16

! DANGER

IMPROPER BLADE POSITION DURING THE STARTING PROCEDURE CAN ALLOW THE BLADE TO CONTACT THE WORK SURFACE BEFORE THE OPERATOR CAN ASSUME A PROPER OPERATING POSITION. THIS OCCURRENCE CAN RESULT IN IMPROPER DAMAGE AND/OR PERSONAL INJURY.

ASSEMBLY INSTRUCTIONS/OPERATIONS

4) Refer to the material supplied by the engine manufacturer for the correct starting, operation and stopping procedures.

5) The RCC130H Series Crack Saw is equipped with a non slip type foot pad to provide additional stability during the engine starting process. FIGURE 17 depicts a proper operator position for starting the Crack Saw.



FIGURE 17

6) The RCC130H Series gasoline powered Crack Saw is not equipped with a centrifugal clutch assembly. The gasoline engine is directly coupled to the arbor shaft by a V-belt reduction.

! DANGER

AS SOON AS THE ENGINE STARTS, THE OPERATOR MUST BE IN A POSITION TO ASSUME DIRECT AND FULL CONTROL OF THE CRACK SAW. FAILURE TO ASSUME DIRECT AND FULL CONTROL CAN RESULT IN PROPERTY DAMAGE AND/OR PERSONAL INJURY.

7) Allow the engine to properly "warm up" and operate without the requirement for choking. Check for excessive machine noise and/or vibration.

! DANGER

DO NOT OPERATE A GASOLINE ENGINE IN CLOSED SPACES WITHOUT PROPER VENTILATION. GASOLINE ENGINES PRODUCE CARBON MONOXIDE FUMES. BREATHING CARBON MONOXIDE FUMES CAN RESULT IN PROPERTY DAMAGE AND/OR PERSONAL INJURY. EXCESSIVE LEVELS OF CARBON MONOXIDE CAN CAUSE DEATH.

8) Stop the engine in accordance with the instructions as described in the material supplied by the engine manufacturer.

! CAUTION

If the Crack Saw and/or an individual component/accessory does not appear to be functioning properly, STOP and do not further operate the Crack Saw until the proper corrective action has been completed. If there are any questions regarding the proper operation of the Crack Saw, contact the Customer Service Department BEFORE further utilization. There is no charge for this service.

OPERATING THE RCC130H CRACK SAW ON THE JOB SITE.

! DANGER

THE SAWING PROCESS PRODUCES EXCESSIVE NOISE, VIBRATION AND FLYING DEBRIS. ALL OPERATORS AND WORK PERSONNEL IN THE VICINITY OF THE CRACK SAW MUST WEAR APPROPRIATE SAFETY EYE WEAR AND HEARING PROTECTION DEVICES. OTHER SAFETY APPAREL AND/OR PROCEDURES, DEEMED NECESSARY BY SUPERVISORY PERSONNEL MUST ALSO BE WORN AND/OR PRACTICED BY ALL APPROPRIATE PERSONNEL.

! DANGER

EXERCISE EXTREME CAUTION WHEN OPERATING THE CRACK SAW IN THE VICINITY OF DECK INSERTS, PIPES, COLUMNS, OPENINGS, LARGE CRACKS, UTILITY OUTLETS OR ANY OBJECT PROTRUDING FROM THE SURFACE. CONTACT WITH SUCH OBJECTS CAN LEAD TO LOSS OF MACHINE CONTROL, RESULTING IN PROPERTY DAMAGE AND/OR PERSONAL INJURY.

! DANGER

DO NOT OPERATE A GASOLINE ENGINE IN CLOSED SPACES WITHOUT PROPER VENTILATION. GASOLINE ENGINES PRODUCE CARBON MONOXIDE FUMES. BREATHING CARBON MONOXIDE FUMES CAN RESULT IN

ASSEMBLY INSTRUCTIONS/OPERATIONS

PROPERTY DAMAGE AND/OR PERSONAL INJURY. EXCESSIVE LEVELS OF CARBON MONOXIDE CAN CAUSE DEATH.

1) The Crack Saw is of a downcut type design as viewed by the operator. The diamond blade is intended to rotate toward the operator to enhance visibility and overall productivity while following a random crack. The down cut action results in a "self propelled" effect toward the operator that substantially enhances machine control and reduces fatigue as long as the diamond blade does not come in direct contact with a protruding obstruction from the floor. Direct contact with such an obstruction can result in rapid and jerky directional movement of the machine. In most operating situations, direct contact with a protruding obstruction from the floor will result in serious damage to the diamond blade. This occurrence may not allow the operator to remain in proper control of the machine.

! DANGER

ALWAYS MAINTAIN PROPER CONTROL OF THE CRACK SAW. IF AN OPERATOR LOOSES CONTROL OF THE MACHINE, A "RUNAWAY" CRACK SAW CAN RESULT IN PROPERTY DAMAGE AND/OR PERSONAL INJURY. BECAUSE OF THE UNIQUE OPERATING CHARACTERISTICS OF THE CRACK SAW, THERE IS NO PROVISION FOR THE ELECTRIC MOTOR/ENGINE TO AUTOMATICALLY STOP IF THE OPERATOR FAILS TO MAINTAIN PROPER CONTROL.

! DANGER

WHEN OPERATING THE CRACK SAW ON ABOVE GROUND FLOOR LEVELS, EXERCISE EXTREME CAUTION TO PREVENT LOSS OF CONTROL THAT COULD ALLOW THE MACHINE AND/OR OPERATOR TO FALL DOWN TO LOWER LEVELS. SUCH AN OCCURRENCE CAN RESULT IN PROPERTY DAMAGE AND/OR PERSONAL INJURY.

2) The crack sawing process is not intended to require additional weight to be applied to the machine for the purpose of increasing productivity and/or stability. No provision for attaching weight is made.

! DANGER

DO NOT OPERATE THE CRACK SAW WITH ADDITIONAL WEIGHT APPLIED DIRECTLY TO THE MACHINE TO INCREASE PRODUCTIVITY RATES AND/OR MACHINE STABILITY. PROPERTY DAMAGE AND/OR PERSONAL INJURY CAN RESULT. PRODUCTIVITY AND/OR STABILITY RELATED PROBLEMS SHOULD BE DIRECTED TO SPECIFIC MECHANICAL PROBLEMS WITH THE MACHINE, OPERATIONAL PROCEDURES AND/OR SPECIFIC MECHANICAL PROBLEMS ASSOCIATED WITH THE DIAMOND BLADE. CONTACT THE CUSTOMER SERVICE DEPARTMENT FOR ASSISTANCE. THERE IS NO CHARGE FOR THIS SERVICE.

3) The Crack Saw is designed to be pulled toward the operator during normal operation to enhance visibility and overall productivity while the blade follows a random crack.

! CAUTION

Operating the Crack Saw by pushing it forward will substantially reduce overall productivity and reduce operator control. The diamond blade will deposit dust and residue materials under the feet of the operator. This configuration will not allow the machine to be utilized with a vacuum system. This occurrence can also reduce operator stability on the work surface and lead to property damage and/or personal injury.

4) Position the Crack Saw over the random crack with the diamond blade directly above and parallel with the crack direction. Align the front casters of the machine parallel with the crack direction to maximize operator control at the start of the sawing process. FIGURE 23.



FIGURE 23

ASSEMBLY INSTRUCTIONS/OPERATIONS

5) Turn the height adjustment lever clockwise to lower the blade into the crack until the desired sawing depth is achieved. Each full turn of the crank lever will raise/lower the blade approximately 1/16 inch.

6) Following the random crack direction and/or pattern with the blade is accomplished by viewing the blade and crack in the louvered opening in the blade guard. The louvers are intended to provide protection for the operator in the event that a diamond segment becomes separated from the blade blank. Probable causes for such occurrences are discussed in detail in the **Troubleshooting** section of this manual.

a) The geometric design of the louvered blade guard is intended to provide a high mathematical percentage of protection for the operator in a normal operating position as described in this manual. The mathematical percentage will decrease for operating positions not described in this manual.

b) In the event of diamond segment separation from the blade blank, there is a high mathematical probability that the segment will be thrown forward against the dust pan located under the main frame or directly against the forward (non louvered) section of the blade guard. The manufacturer has conducted extensive testing to substantiate this theory. In actual field tests, diamond segments were purposely separated from the blade blanks through abusive operational techniques. In all field tests, no separated diamond segments made direct contact with the blade guard louvers.

c) In the very low probability that a diamond segment would make direct contact with the blade guard louvers, the geometric design has a high mathematical probability to not allow the segment to penetrate the vertical plane as defined by the location of the louvers. The spaces, angle orientation and number of louvers minimize the mathematical probability that a segment can penetrate the vertical plane, exit the louvers and eventually strike the operator.

d) The geometric configuration of the louvers are designed to allow for adequate and/or proper visibility for the operator during the sawing process. With use, concrete and/or asphalt dust will accumulate at the bottom of the blade guard opening. At regular intervals, this material should be removed to enhance operator visibility during the sawing process.

⚠ DANGER

DO NOT MODIFY THE ORIGINAL OPERATING CONFIGURATION FOR THE LOUVERS FOR ANY REASON. MODIFICATIONS TO THE LOUVERS CAN RESULT IN PROPERTY DAMAGE AND/OR PERSONAL INJURY.

7) Proper operator posture and stance will enhance operational safety and overall productivity. FIGURE 24 depicts a proper operator's position. FIGURE 25 depicts an improper operator's position that can accelerate fatigue, decrease productivity and reduce safety. The downcut orientation of the diamond blade will normally produce a "self-propelled" effect against the operator. This effect is intended to reduce the operator fatigue associated with the operation of the machine and to increase overall productivity.

8) In some operating conditions, it may be necessary for the operator to apply a resisting force (push) against the operator handle to counteract the "self-propelled" effect. In some other operating conditions, it may be necessary for the operator to apply a force (pull with) to the operator handle in order to assist the sawing action of the Crack Saw.



FIGURE 24



FIGURE 25

The amount and direction of forces to apply to the operator handle are governed by, but not necessarily limited to the following factors:

- a) Average Random Crack Width.
- b) Diamond Blade Saw Width.
- c) Sawing Depth.
- d) Tensile strength of the material being sawed.
- e) Matrix material of the diamond blade segments in consideration of the aggregate type, amount and/or hardness contained in the material being sawed.
- f) Service condition of the diamond blade segments.
- g) Operating RPM speed range for the diamond blade.
- 9) For normal job applications, operate the engine at a maximum, governed speed of 3450 RPM. Consult the material supplied by the engine manufacturer and the **Specifications** section for specific information. If you have any questions regarding specific job applications, contact the Customer Service Department for information. There is no charge for this service. Additional information can be obtained from the Masonry and Concrete Saw Manufacturers Institute, 30200 Detroit Road, Cleveland, OH 44145-1967.

⚠ DANGER

THE CRACK SAW IS DESIGNED FOR THE ENGINE TO OPERATE AT A MAXIMUM, GOVERNED SPEED OF 3450 RPM. THIS ENGINE SPEED AND THE V-BELT REDUCTION SYSTEM ALLOWS THE DIAMOND BLADE TO OPERATE WITHIN THE INDUSTRY ACCEPTED RPM SPEED RANGE. FIELD CHANGES AND/OR ALTERATIONS MADE TO THE FACTORY SET ENGINE SPEED RANGE AND/OR V-BELT PULLEY(S) CAN ALLOW THE DIAMOND BLADE TO OPERATE OUTSIDE THE INDUSTRY ACCEPTED RPM SPEED RANGE. THIS OCCURRENCE CAN RESULT IN PROPERTY DAMAGE AND/OR PERSONAL INJURY.

10) The wide variety of potential work surface materials along with the corresponding variety of job site environments, make it impossible to develop a standardized operating procedure for the Crack Saw. Use of the Crack Saw will require constant trial and error testing until satisfactory results are achieved. Experience gained over time and common sense will help minimize the amount of necessary testing. Many factors will directly affect the operating parameters and/or techniques utilized for a specialized job application. Some of these factors include:

a) Work surface material yield and tensile values. As a general rule, these values will determine material removal rate per unit of time. Materials with high yield and tensile values will characteristically resist/limit material penetration. For such materials, the accepted procedure is to make a number of multiple passes over the work surface rather than attempt to make a single, deep pass. The net effect is to actually increase productivity: more material removed in less time. Other added benefits to this technique are decreased vibration, less operator fatigue and increased component service life.

b) The width of the random crack in comparison to the required cutting width and depth. For example, if the random crack has an average width of 1/8 inch, productivity rates will be greater with the use of a 1/4 inch wide blade over that delivered by a 1/2 inch wide blade. The same analogy can also be used for the cutting depth. Productivity rates will be greater for a 1/2 inch deep cut than a 1-inch deep cut. Deeper cuts also require additional time for the blade to "clear itself" when following a random crack pattern.

ASSEMBLY INSTRUCTIONS/OPERATIONS

11) The sawing process on many work surface materials can produce sparks, dust and other foreign particle contamination.

! DANGER

SPARKS PRODUCED BY THE ACTION OF THE DIAMOND BLADE AGAINST THE WORK SURFACE (FOR EXAMPLE: STRIKING ANCHOR BOLTS) MAY COME IN CONTACT WITH MATERIALS THAT CAN RESULT IN A FIRE AND/OR EXPLOSION. THIS OCCURRENCE CAN RESULT IN PROPERTY DAMAGE AND/OR PERSONAL INJURY.

! DANGER

THE CREATION OF DUST AND OTHER FOREIGN PARTICLE CONTAMINATION FROM THE OPERATIONAL PROCESS CAN RESULT IN PROPERTY DAMAGE AND/OR PERSONAL INJURY. FOR SUCH OPERATING CONDITIONS, ALWAYS WEAR A NIOSH/MSHA APPROVED DUST/MIST RESPIRATOR. CONSULT APPLICABLE OSHA REGULATIONS FOR SPECIFIC INFORMATION.

12) Dust and other particle contamination can be controlled by the following methods:

a) The Crack Saw is equipped with a 3 inch outside diameter vacuum tube adaptor located at the front of the machine. An industrial type vacuum system can be attached to the Crack Saw to remove/control dust and other particle contamination from the work surface. A hose clamp is sometimes required to properly secure the vacuum hose to the vacuum tube. FIGURE 26.

! CAUTION

Use of a vacuum system with the Crack Saw will not totally eliminate or provide 100 per cent dust and other particle contamination removal from the atmosphere and work surface. Secondary dust and other particle contamination removal procedures from the atmosphere and work surface will normally be required.



FIGURE 26

! DANGER

ALWAYS UTILIZE A VACUUM SYSTEM TO OPERATE WITHIN THE SPECIFIC JOB SITE REQUIREMENT. DUST MATERIAL CAN MEET CLASS II OR CLASS III SPECIFICATIONS OF THE NATIONAL ELECTRIC CODE® FOR HAZARDOUS LOCATION CLASSIFICATIONS. CONSIDERATION MUST ALSO BE GIVEN TO THE CREATION OF HAZARDOUS TYPE MATERIALS REQUIRING SPECIFIC DISPOSAL PROCEDURES. DETERMINE THAT THE VACUUM SYSTEM IS PROPERLY DESIGNED TO OPERATE WITHIN THESE ATMOSPHERES. CONSULT CURRENT NATIONAL ELECTRIC CODE®, OSHA AND ENVIRONMENTAL PROTECTION AGENCY REGULATIONS FOR SPECIFIC INFORMATION.

b) A water stream directed to the blade can be an effective method of reducing dust effects and increasing service life at the same time. The optional RCCWC Wet Sawing Kit can be installed to direct a continuous stream of water to both sides of the diamond blade. FIGURE 27. The kit includes a standard globe type valve to control water feed rates and is directly coupled to a water hose. Potential negative effects of this procedure is that the water and slurry mixture will require additional time for disposal and proper drying before crack filling work can be initiated. Under specific circumstances, the resulting slurry mixture can also be classified as a hazardous material, requiring proper disposal procedures.

13) The Crack Saw is equipped with a quick change height lever designed to raise the diamond blade clear

ASSEMBLY INSTRUCTIONS/OPERATIONS

of the work surface when deployed to its maximum up position. FIGURE 28.

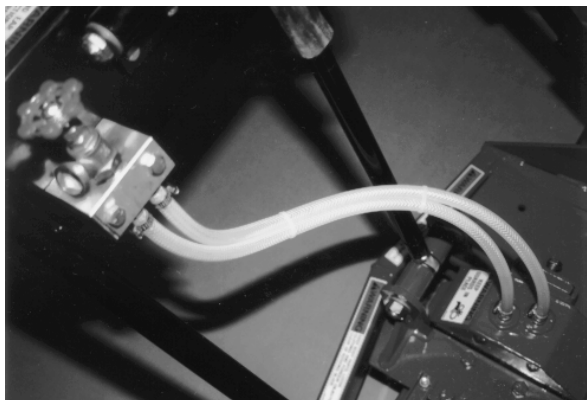

FIGURE 27



FIGURE 28

The quick-change height lever is intended to provide a fast method to raise the blade for the following reasons:

a) When the sawing process is completed for a random crack, the blade can be quickly raised from the work surface and the machine moved by the operator to another random crack on the job site. Lowering the quick change lever to the full down position will return the diamond blade to the specific depth as originally determined by the height adjustment lever.

FIGURE 29. The quick change height lever is intended to produce uniform sawing depths for any specific job application.

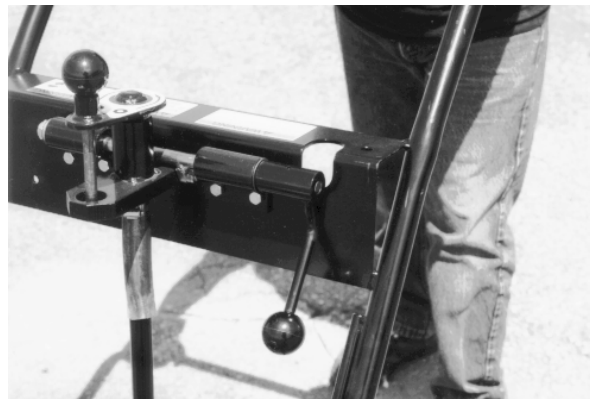

FIGURE 29

⚠ DANGER

EXERCISE EXTREME CAUTION WHEN MOVING THE CRACK SAW ON THE JOB SITE WITH THE POWER SOURCE RUNNING AND THE QUICK CHANGE HEIGHT LEVER OVER CENTER TO ITS REAR MOST (UP) POSITION. IN THIS OPERATING CONFIGURATION, THE DIAMOND BLADE CAN COME IN DIRECT CONTACT WITH FOREIGN OBJECTS AND THE WORK SURFACE ITSELF. THIS OCCURRENCE CAN SUBSTANTIALLY REDUCE MACHINE CONTROL AND PRODUCE FLYING OBJECTS, RESULTING IN PROPERTY DAMAGE AND/OR PERSONAL INJURY. CAUTION ALL ONLOOKERS REGARDING THE POSSIBILITY OF FLYING OBJECTS.

b) If the sawing process overloads the power source to cause complete stoppage, the diamond blade can be readily raised by the operator to clear the work surface before the power source is restarted.

⚠ DANGER

DO NOT START AND/OR RESTART THE POWER SOURCE WITH THE DIAMOND BLADE IN DIRECT CONTACT WITH THE WORK SURFACE. BEFORE STARTING AND/OR RESTARTING THE POWER SOURCE, RAISE THE QUICK CHANGE HEIGHT LEVER OVER CENTER TO ITS REAR MOST (UP) POSITION TO ALLOW THE DIAMOND BLADE TO COMPLETELY CLEAR THE WORK SURFACE. IF THIS ACTION DOES NOT COMPLETELY RAISE THE DIAMOND BLADE FROM THE WORK SURFACE, DETERMINE THAT

ASSEMBLY INSTRUCTIONS/OPERATIONS

A BLADE OF PROPER DIMENSIONS IS BEING UTILIZED. IF THERE ARE ANY QUESTION REGARDING PROPER BLADE DIMENSIONS FOR USE WITH THE CRACK SAW, CONTACT THE CUSTOMER SERVICE DEPARTMENT FOR SPECIFIC INFORMATION. THERE IS NO CHARGE FOR THIS SERVICE.

! DANGER

STARTING AND/OR RESTARTING THE CRACK SAW WITH THE DIAMOND BLADE IN DIRECT CONTACT WITH THE WORK SURFACE CAN SUBSTANTIALLY REDUCE MACHINE CONTROL, RESULTING IN PROPERTY DAMAGE AND/OR PERSONAL INJURY.

14) Generally speaking, the majority of random crack patterns follow a predominantly straight line with no more than 20° variance from an imaginary center line. FIGURE 30. These random crack patterns are easily sawed to the required widths and depths by the properly described diamond blades.

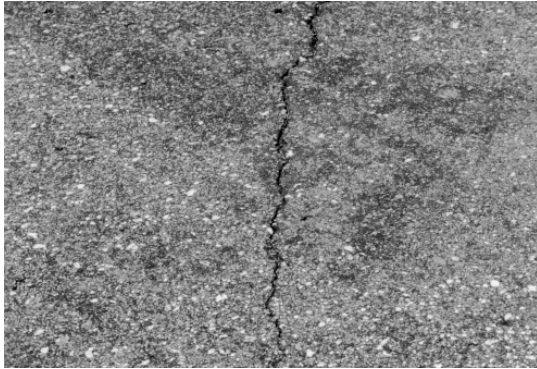

FIGURE 30

However, there are many instances where the random crack pattern follows perpendicular (90°) to more obtuse (91° to 179°) angles. FIGURE 31. These angles will generally not allow the Crack Saw to properly follow the resulting patterns without significantly reducing operator control, overall productivity and causing severe damage the diamond blade.

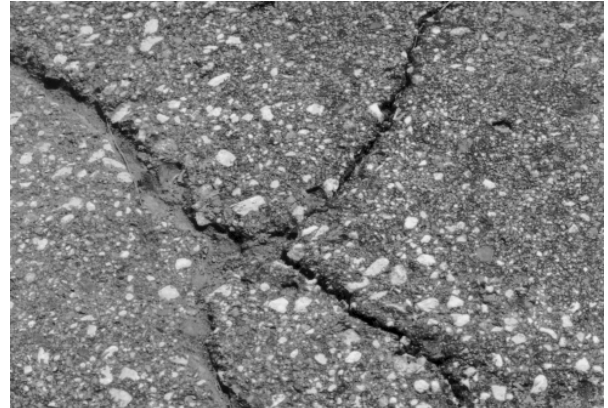

FIGURE 31

These types of patterns can be properly sawed by a multiple step process. A segment of the crack is first sawed by the described process (FIGURE 32) and the machine repositioned by the described procedure to saw the intersecting segment. FIGURE 33. This procedure can be repeated as necessary by the geometry of the specific random crack pattern. Following this procedure is especially important when deep (greater than 1/2 inch) saw cuts are required for proper crack filling methods. By utilizing this operating procedure, intricate random crack patterns can be properly sawed while maximizing operator control, overall productivity and extending blade service life.



FIGURE 32



FIGURE 33

! DANGER

IMPROPER SAWING PROCEDURES FOR ANY SPECIFIC RANDOM CRACK CAN SUBSTANTIALLY REDUCE OPERATOR CONTROL, OVERALL PRODUCTIVITY AND CAUSE SEVERE DIAMOND BLADE DAMAGE, RESULTING IN PROPERTY DAMAGE AND/OR PERSONAL INJURY.

15) Increased productivity rates can usually be achieved in intricate random crack patterns with the use of a wider diamond blade. FIGURE 34.



FIGURE 34

16) Normal usage of the Crack Saw will allow the build-up and accumulation of work surface materials on interior surfaces. It is highly recommended that both the interior and exterior surfaces be properly cleaned after the completion of each usage.

! CAUTION

Failure to properly clean the interior surfaces of the Crack Saw can result in dried material build-up and accumulation directly affecting bearing and V-Belt service life.

! DANGER

EXERCISE EXTREME CAUTION WHEN UTILIZING ANY SOLVENT TO REMOVE ACCUMULATED MATERIALS FROM THE SURFACES OF THE MACHINE AND RELATED COMPONENTS. MANY SOLVENTS ARE FLAMMABLE. DO NOT SMOKE OR INTRODUCE FLAME IN THE WORK AREA. PROVIDE ADEQUATE VENTILATION AND WEAR PROPER SAFETY APPAREL.

! DANGER

PROPERLY DISPOSE OF ALL ACCUMULATED MATERIALS PER OSHA AND ENVIRONMENTAL PROTECTION AGENCY CODES AND REGULATIONS. MANY ACCUMULATED MATERIALS CAN BE CLASSIFIED AS HAZARDOUS AND REQUIRE PROPER DISPOSAL PROCEDURES. CONTACT THE APPLICABLE GOVERNMENT AND/OR PRIVATE AGENCIES FOR SPECIFIC INFORMATION.

17) On job applications where the work process creates a considerable amount of loose material, it can become almost impossible to determine proper cutting direction for the blade and the extent of work already accomplished. The problem can be compounded if a vacuum system is not utilized. Loose material should be removed by sweeping or other, appropriate processes and the Crack Saw utilized until conditions again warrant removing the accumulated material.

ASSEMBLY INSTRUCTIONS/OPERATIONS

STOPPING THE RCC130H SERIES GASOLINE POWERED CRACK SAWS.

1) Position the quick change height lever over center to its rear most (up) position.

2) Stop the Crack Saw by moving the engine throttle control lever to the idle speed position. Turn the ignition switch located on the engine to the OFF position. Consult the material supplied by the engine manufacturer for specific information.

OPERATIONAL PARAMETERS AND TECHNIQUES FOR THE RCC130H SERIES CRACK SAW.

Basic definitions.

There are very few aspects of the pavement maintenance industry that all members, including contractors, engineers, researchers and government agencies can agree on except the inevitability of cracks forming in all types of pavements. To properly address the crack repair procedures, contractors must have a basic understanding of why crack repair is beneficial, crack types to address and the repair materials and methods available.

A basic understanding of the difference between crack filling and crack sealing and the working knowledge to understand which one is appropriate for a specific job application is essential for any pavement maintenance contractor.

An industry accepted definition of crack filling is the placement of materials into cracks to reduce water intrusion and reinforce the adjacent pavement. Crack sealing is the placement of specialized materials either above or into working cracks to prevent the intrusion of water and incompressibles such as sand, aggregate and dirt.

Why Do It at All?

Crack sealing is used as a first line of defense against the deterioration of pavement because of its inherent benefits:

a) It protects the base and sub-base. A good pavement requires a base and sub-base of high structural integrity. Effective crack sealing procedures eliminate water from entering and weakening these areas. The resulting weakness can result in the loss of structural support, which can then further result in the formation of additional cracks and settling around the crack area.

b) It preserves the pavement adjacent to the cracking. Cracks that are properly cleaned and sealed contain filler materials that firmly adhere to the crack sides during times of both expansion and contraction. Without the addition of these filler materials, the adjacent pavement would have increased exposure to the elements, resulting in increased oxidation of the binder, hardening and secondary cracking along the main crack.

c) It eliminates the damaging effects of incompressibles such as sand, aggregate and dirt. When these materials get into a crack they can restrict crack closure during periods of warm weather. The resulting compressive stresses at the faces can create spalling and loosening. In some highly oxidized pavements these stresses can even create pavement lipping, which is the upheaval of pavements at their transverse cracks.

d) It extends pavement life. Sealing procedures allow the contractor to effectively exert control over the base and sub-base conditions, pavement interference and crack growth, thereby extending the pavement's service life.

Types of Cracks.

There are several basic types of cracks:

a) Reflective. This type of crack appears primarily in resurfacing projects, although it can also occur in a new pavement surface. Reflective cracks occur when an existing crack or joint in the underlying pavement structure reflects upward through the surface.

b) Joint. A joint is the edge of the individual paving pass made during construction. Such construction joints usually have a lower density than the remaining material. When the placed mats do not bond properly (for any number of reasons), joint cracks can appear.

c) Slippage. Slippage cracks are usually crescent shaped and are created by heavy traffic that is either stopping, turning or climbing a hill. Resultant stresses can cause a bond failure between upper and lower pavement layers. The open end of the U shaped crack always points in the direction of the applied force.

d) Thermal. All pavements expand and contract due to temperature variations. This movement can create cracks. To better allow for movement, pavements need to be constructed with the correct percentage of air voids, which provide for internal stress relief. When the air void percentage is not correct, thermal cracks appear.

ASSEMBLY INSTRUCTIONS/OPERATIONS

e) Fatigue or alligator. Over time, as a pavement surface ages, it becomes more rigid and has less ability to tolerate vertical load deflections. This occurrence creates a tension and pulling apart in the pavement and results in alligator type cracking. Such cracking can also occur from improper structural capacity and aging. It is generally recommended that alligatored areas be removed and replaced rather than be filled or sealed.

f) Block. This type of crack forms a square pattern, with cracks intersecting at approximate right angles. A common cause of block cracks on asphalt pavements is a lack of traffic, which constantly kneads the pavement and keeps it flexible. Other causes can include excessive air voids in the material.

g) Edge. Edge cracks appear only parallel to and within usually 18 inches of the pavement edge. Cause can include substandard base, lack of shoulder support, inadequate drainage or damage caused by frost.

Equipment and Materials.

Pavement contractors can select from a wide variety of hot or cold applied materials to seal cracks. Unlike cold materials, hot applied sealers are first prepared prior to application. The standard method is a double boiler kettle, which consists of an inner chamber that contains and agitates the sealant material and an outer chamber serving as the heat source.

Heated sealers include rubberized asphalt, low modulus rubberized asphalt, fiberized asphalt and asphalt rubber. Cold applied materials are usually comprised of a self leveling silicone and modified emulsions.

When making a material selection, the pavement contractor must consider many factors. It is critical that the material be placed efficiently and deliver satisfactory performance given the related environmental factors. Other significant factors include preparation and cure times, adhesiveness to the crack sides, cohesiveness in the crack center, resistance to softening and flow, aging and weathering.

Preparation and Application.

The primary purpose of the Crack Saw is to produce a proper configuration in the crack area for the placement of the sealing material. The exact configuration is dependent upon many factors including crack type, pavement downtime and budget restrictions. There are numerous configurations, although all can be grouped into four general classifications:

a) Flush fill. The material is simply dispensed into an existing unsawed crack and the excess struck off.

b) Reservoir. Material is placed only within the confines of a sawed crack, either flush with or slightly below the pavement surface.

c) Overband. Material is placed into and over an unsawed crack and shaped into either a band aid configuration (3 to 5 inches wide and 1/8 inch thick) or given a slight cap.

d) Combination. Material is placed into and over a sawed crack, then is shaped by squeegee into a band centered over the crack reservoir.

The configuration of the random crack ultimately determines the specific type and/or quantity of material utilized in the process.

Maintenance/Service

PREVENTATIVE MAINTENANCE CHECK LIST.

The normal operation of the Crack Saw produces extreme dirt and dust, along with levels of random vibration. Before operating the Crack Saw, the following service list should be accomplished. This list is for reference only and is not intended to be all inclusive. Other subject areas can be added at the discretion of the owner(s) and/or operator(s):

- 1) Check all fasteners for proper torque values. If a fastener requires retorquing, consult a torque chart for proper value. Properly discard and replace any worn fastener with a factory approved, replacement part.
- 2) Check the V-belts for wear. Adjust or replace as necessary. Check pulleys for wear and proper alignment. Many loose materials created as a result of operating processes can be extremely abrasive.
- 3) Keep the Crack Saw clean. Wash the unit after each use. Keep loose materials from accumulating around engine cooling fins. Determine that the interior sections of the frame are free of material build-up. Such a build-up can restrict the operating process and present a potential safety hazard. Clean and remove any material build-up from the Crack Saw after each use.
- 4) Engine service life can be extended with proper air cleaner maintenance. Consult the material supplied by the engine manufacturer for specific information.
- 5) Check for proper oil level. Always use clean, high quality engine oil. Change oil as required. Consult the material supplied by the engine manufacturer for specific information.
- 6) Remove material accumulations from the exterior surfaces of the electric motor. The electric motor is a totally enclosed, fan cooled (TEFC) design. Keep the fan fins clear of material accumulations to enhance air flow over the motor exterior for cooling purposes.

DANGER

DO NOT PERFORM PREVENTATIVE MAINTENANCE CHECKS WITH THE ENGINE RUNNING. DISCONNECT THE SPARK BEFORE PERFORMING ANY MAINTENANCE RECONNECT THE SPARK PLUG BEFORE IMPROPER PROCEDURES CAN RESULT IN PROPERTY DAMAGE AND/OR PERSONAL INJURY.

CHECKING V-BELT TENSION AND ALIGNMENT.

Application: All Models.

Proper V-belt tension and alignment is essential for smooth transmission of horsepower and extended service life. Improper tension and alignment will accelerate V-belt wear and contribute to decreased productivity. The V-belt is tensioned at the factory with the maximum recommended tension force. Check the belt tension at least two times during the first day of operation as there will normally be a rapid decrease in belt tension until it has been run in. Check the belt tension every eight hours of operation thereafter and maintain tension within the recommended range. The correct operating tension for a V-belt drive is the lowest tension at which it will not slip under peak load conditions.

Tools Required:

- 1 each, 16 inch minimum length straightedge.
- 1 each, 10 lbs minimum capacity, tension scale or belt tension tool.

- 1) Position the Crack Saw on a suitable work bench with the V-belts approximately at waist level.
- 2) Disconnect the engine spark plug wire.
- 3) Remove the belt guard from the main frame. Clean the inside of the belt guard with an appropriate solvent. Check for signs of wear and damage. Secure in a proper storage area.

CAUTION

Observe all applicable safety precautions for the solvent.

- 4) Check the belt tension using the spring scale or belt tension tool midway between the engine/motor pulley and the arbor shaft pulley. Belt tension should measure approximately 0.22 inch at 3-1/4 to 4-3/8 lbs. measured force range. FIGURE 35. If tension is within specifications, proceed to Step 5. If tension is not within specifications, refer to INSTALLING A REPLACEMENT V-BELT for specific information.

⚠ DANGER

UNEXPECTED MACHINE START UP CAN RESULT IN PROPERTY DAMAGE AND/OR PERSONAL INJURY.

INSTALLING A REPLACEMENT V-BELT OR PULLEY.

Tools Required:
2 each, 9/16 wrenches.
1 each, 5/32 Allen wrench.
1 each, 16 inch minimum length straightedge.
1 each, 10 lbs minimum capacity, tension scale or belt tension tool.

Parts Required:

2 each, PN BX34 V-belt (if required).
1 each, PN CS8-0260 pulley assembly (if required).
1 each, PN CS8-0270 pulley assembly (if required).

1) Position the Crack Saw on a suitable work surface with the V-belts approximately at waist level.

2) If the Crack Saw is powered by an engine, disconnect the spark plug wire. If powered by an electric motor, disconnect the extension cord or Crack Saw from the power source. If the Crack Saw is powered with a Propane converted engine, the Propane cylinder must be removed from the main frame to better facilitate the maintenance process. Determine that the Propane cylinder valve is fully closed before uncoupling the hose. Secure in a proper storage area. Using the 9/16 inch wrenches, remove the belt guard from the main frame. Clean the inside of the belt guard with an appropriate solvent. Check for signs of wear and damage. Secure in a proper storage area.

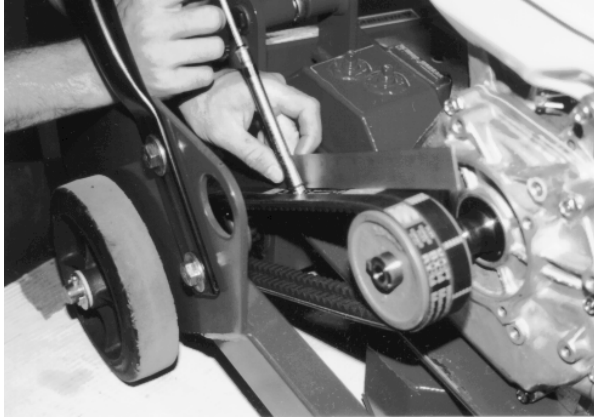

FIGURE 35

5) Belt alignment is checked with the straightedge. Place the straightedge squarely against the arbor shaft pulley. Properly aligned pulleys should also place the straightedge squarely against the engine/motor pulley. Remove the straightedge and rotate the engine/motor pulley 120 degrees. Recheck alignment with the straightedge. Repeat the process until the engine/motor pulley is rotated a full 360 degrees. Maximum allowable misalignment is $\pm 1/32$ inch. If pulley alignment is not within specifications, refer to **INSTALLING A REPLACEMENT V-BELT** for specific information. FIGURE 36.

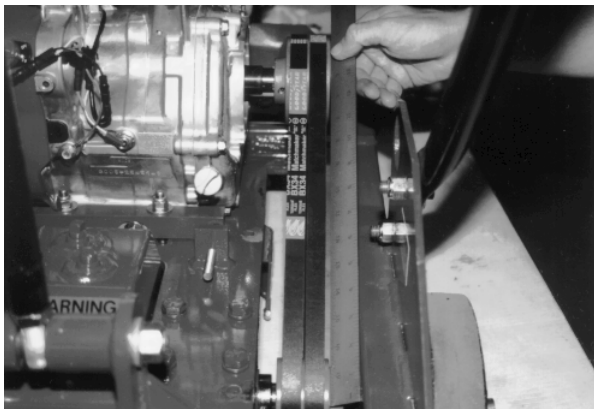

FIGURE 36

6) Reinstall the belt guard to the main frame. Determine that all safety related decals affixed to the belt guard are fully readable. If any decal is not fully readable, replace with a factory approved, replacement part only.

7) Reconnect the engine spark plug wire. Position.

⚠ CAUTION

Observe all applicable safety precautions for the solvent.

3) Remove the belt guard from the main frame. Clean the inside of the belt guard with an appropriate solvent. Check for signs of wear and damage. Secure in a proper storage area.

4) Using the 9/16 inch wrenches, loosen the engine/motor mounting capscrews.

5) With the same wrenches, rotate the engine take-up capscrews counterclockwise to loosen the V-belts and allow the engine/electric motor to slide toward the operator handle. FIGURE 37.

6) Remove the worn V-belts. Inspect the engine/electric motor and arbor shaft pulleys for wear and damage. Install the replacement belts, PN BX34 in pairs. The Crack Saw utilizes two V-belts. Always install replacement belts in matched pairs. Never replace just one of the V-belts.

⚠ CAUTION

Do not operate the Crack Saw with only one V-belt installed. One V-belt is not capable of transmitting proper horsepower and torque levels to the arbor shaft.

a) Do not install replacement belts if the pulleys have excessively worn grooves. Such pulleys should be replaced to insure proper belt fit. Operating the V-belts in worn pulley grooves will accelerate wear, reduce horsepower and torque levels and significantly reduce component service life.

b) A V-belt should never be forced over a pulley. More belts are broken from this cause than from actual failure in service.

c) Keep the belts as clean and free of foreign material as possible. Do not use belt dressing.

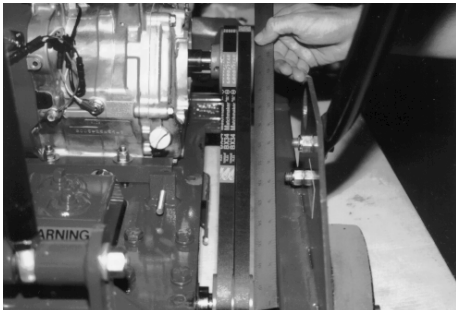

FIGURE 37

7) Tighten the engine/electric motor attachment capscrews until they just begin to apply tension to the engine/electric motor. DO NOT OVER TIGHTEN. Alternately tighten the take-up capscrews until slight tension is applied to the V-belt.

8) Belt alignment is checked with the straightedge. Place the straightedge squarely against the arbor shaft pulley. Properly aligned pulleys should also place the straightedge squarely against the engine/electric motor pulley. Remove the straightedge and rotate the engine pulley 120 degrees. Recheck the alignment with the straightedge. Repeat the process until the engine/electric motor pulley has been rotated a full 360 degrees. Maximum allowable misalignment is $\pm 1/32$ inch. FIGURE 38.

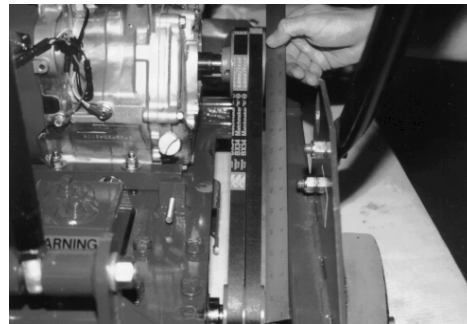

FIGURE 38

9) Apply increased belt tension by progressively tightening the take-up capscrews against the engine/electric motor.

a) Recheck V-belt alignment.

b) Check belt tension with the spring scale or belt tension tool midway between the engine/electric motor and arbor shaft pulleys. Belt deflection should measure approximately .20 inch at 4 to 5-1/2 pounds force. FIGURE 39.

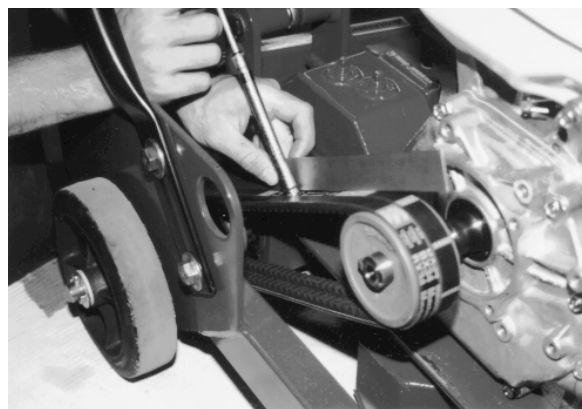

FIGURE 39

c) If the belt tension and alignment are within specifications, torque the engine/electric motor attachment capscrews to 35 ft lbs (47 N.m).

d) Recheck V-belt tension and alignment.

10) Reinstall the belt guard to the main frame. Install the flat washers and self locking hexagon nuts. Determine that all safety related decals affixed to the belt guard are fully readable. If any decal is not fully readable, replace with a factory approved replacement part only.

11) Reconnect the engine spark plug wire.

DANGER

**UNEXPECTED MACHINE START UP CAN RESULT IN PROPERTY DAMAGE AND/OR PERSONAL INJURY.
INSTALLING REPLACEMENT BEARINGS ON THE ARBOR SHAFT.**

Application: All Models.

Tools Required:

2 each, 9/16 inch wrenches.

1 each, 3/4 inch wrench.

1 each, 5/32 inch Allen wrench.

1 each, pliers for large, external type snap rings.

1 each, shop press.

Parts Required:

2 each, PN 5208-2RS sealed bearings.

1 each, container of bearing and shaft locking grade, anaerobic adhesive/sealant.

1 each, PN 5160-156 snap ring (if required).

1 each, PN CS8-0230 bearing block (if required).

1 each, PN CS8-0030 arbor shaft (if required).

1) Position the Crack Saw on a suitable work surface with the V-belt approximately at waist level.

2) If the Crack Saw is powered by an engine, disconnect the engine spark plug wire. If powered by an electric motor, disconnect the extension cord or Crack Saw from the power source. If the Crack Saw is equipped with a Propane converted engine, the Propane cylinder must be removed from the main frame to better facilitate the maintenance process. Determine that the Propane cylinder is fully closed before uncoupling the hose. Secure in a proper storage area.

3) Using the 9/16 inch wrenches, remove the belt guard from the main frame. Clean the inside of the belt guard with an appropriate solvent. Check for signs of wear and damage. Secure in a proper storage area.

CAUTION

Observe all applicable safety precautions for the solvent.

4) Remove the V-belt and arbor shaft pulley. Refer to INSTALLING A REPLACEMENT V-BELT OR PULLEY for specific information. Remove the blade guard from the main frame. Clean the interior and exterior surfaces of the blade guard with an appropriate solvent. Check for signs of wear and damage.

5) Using the 3/4 inch wrench, remove the bearing block/arbor shaft from the main frame. Clean the arbor shaft/bearing block assembly with an appropriate solvent. Check for signs of wear and damage.

6) Position the bearing block/arbor shaft assembly on a suitable work surface. Use the snap ring pliers to remove the snap ring. FIGURE 40.

CAUTION

Wear safety glasses and other appropriate safety apparel when removing the snap ring or performing any work with an arbor press. Caution all onlookers about the possibility of flying debris and personal injury.

7) Using the Allen wrench, remove the Allen screws that retain the hub body to the arbor shaft. If the hub body does not freely remove itself from the arbor shaft, position the assembly in a suitable arbor press. FIGURE 41. The hub can be removed by pressing the hub body from the arbor shaft. As the hub body separates from the arbor shaft, the arbor shaft/bearing block assembly can fall directly to the work surface.

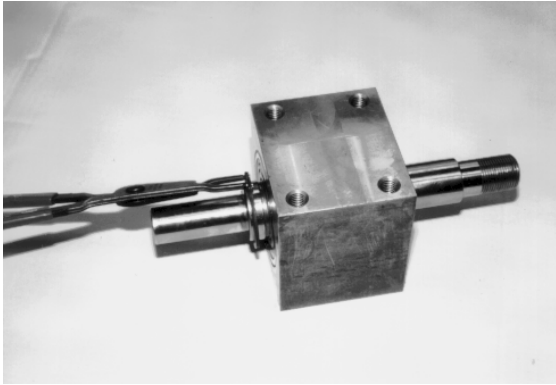

FIGURE 40

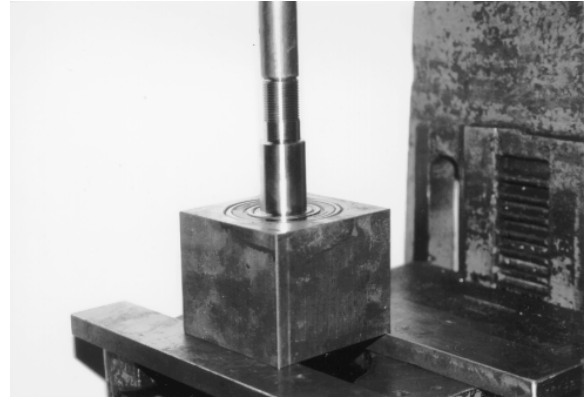

FIGURE 42

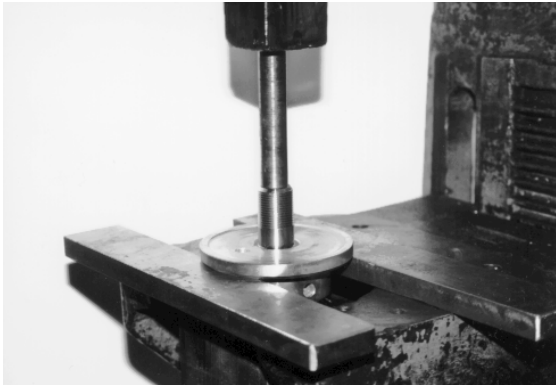

FIGURE 41

⚠ CAUTION

Exercise extreme caution when pressing the hub body from the arbor shaft/bearing block assembly. Improper activities can result in the components striking body parts, resulting in property damage and/or personal injury.

8) Position the arbor shaft assembly in a suitable arbor press with the snap ring shoulder facing down. Determine that the bearing block face is properly supported. The outside diameter of the bearing must be clear for axial movement. Press the arbor shaft assembly from the bearing block. FIGURE 42. Reposition the assembly and press the remaining bearing from the bearing block. FIGURE 43.

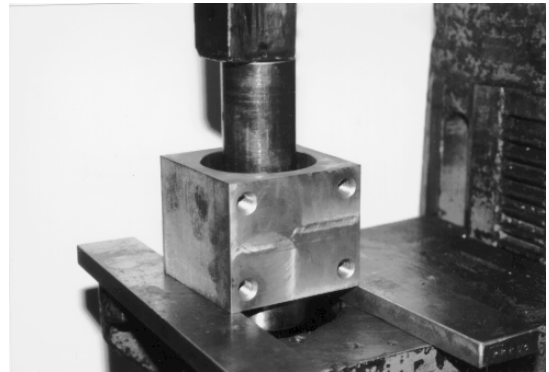

FIGURE 43

9) Clean and inspect the arbor shaft and bearing block for wear and damage. Replace any questionable component with a factory replacement part only.

10) Clean the outside bore diameter of the replacement bearing with an appropriate solvent. Apply a suitable amount of anaerobic adhesive/sealant to the outside diameter of the bearing. Determine that the outside diameter of the bearing will absorb the thrust from the pressing process. The inside bore of the bearing should not receive any direct thrust force. Press the replacement bearing into the bearing block until it seats itself against the flange.

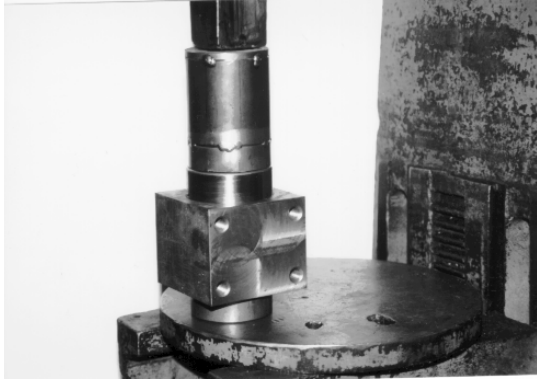

FIGURE 44.

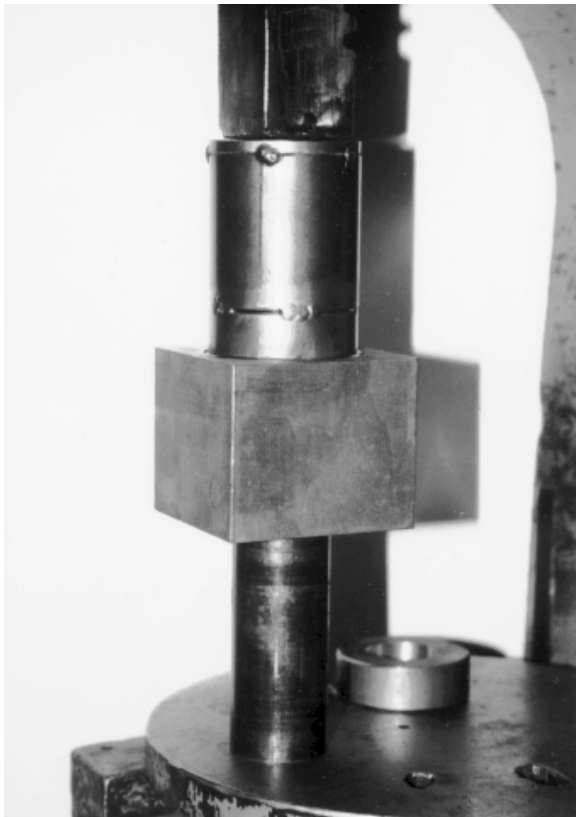

FIGURE 45

11) Clean the bearing journal areas of the arbor shaft with an appropriate solvent. Apply a suitable amount of anaerobic adhesive/sealant to the bearing journal area located near the snap ring groove. Press the arbor shaft into the replacement bearing until it seats itself against the inner race. FIGURE 45.

12) Clean the inside and outside bore of the second replacement bearing with an appropriate solvent. Apply a suitable amount of anaerobic adhesive/sealant to the inside and outside bore. Install the replacement bearing over the arbor shaft. Determine that both the inside and outside bores of the bearing will absorb the thrust from the pressing process. Press the replacement bearing into the bearing housing until it seats itself against the flange. This procedure will minimize the potential for improper bearing preloading. FIGURE 46.



FIGURE 46

13) Reinstall the snap ring into the snap ring groove on the arbor shaft.

⚠ CAUTION

Wear safety glasses and other appropriate safety apparel when removing the snap ring or performing any work with an arbor press. Caution all onlookers about the possibility of flying debris and personal injury.

14) Rotate the arbor shaft by hand to determine the amount of bearing preloading created as a result of the installation process.

Properly installed replacement bearings should rotate without excessive friction, drag and/or "rough spots". If these symptoms occur after assembly, the bearings were improperly supported when pressed into the bearing block. The resulting thrust placed upon the bearing exceeded the static capacity. Bearing operating with these characteristics will deliver minimal service life and be prone to premature failure.

15) Inspect the hub body drive key and hub body for wear and/or damage. Replace any questionable component with a factory replacement part only. Reinstall the hub body drive key into the arbor shaft. Reinstall the hub body to the arbor shaft until it fully seats against the inside bore of the bearing. Reinstall the two Allen screws into the hub body and properly torque.

16) Inspect the arbor shaft drive key and arbor shaft pulley for wear and/or damage. Replace any questionable component with a factory replacement part only. Reinstall the arbor shaft pulley drive key into the arbor shaft. Reinstall the arbor shaft pulley. Do not torque the Allen screws at this time. The Allen screws will be tightened after determining that the engine/electric motor and arbor shaft pulleys are in proper alignment. See Step 19.

17) Reassemble the bearing block to the main frame. Determine that the arbor shaft rotates perpendicular to both the vertical and horizontal planes as defined by the direction of machine travel.

18) Follow the instructions as outlined for **INSTALLING A REPLACEMENT V-BELT OR PULLEY** to complete the assembly of the pulleys, V-belts and belt guard.

19) Reconnect the engine spark plug wire .

⚠ DANGER

UNEXPECTED MACHINE START UP CAN RESULT IN PROPERTY DAMAGE AND/OR PERSONAL INJURY.

LUBRICATION REQUIREMENTS.

Application: All Models.

Parts Required:

1 each, standard grease gun filled with one of the following: ESSO Beacon 325, Shell Alvania #2, Chevron SRI, or equivalent.

1 each, container of dry film lubricant.

1) Lubricate the rigid caster wheel bearing with a dry film lubricant only. Dry film lubricants dry immediately upon contact. Use sparingly. Excess lubricant will attract the fine grained, powdered materials described in this manual and directly affect bearing service life.

⚠ CAUTION

Do not lubricate the rigid caster wheels with any type of grease material. Grease will attract foreign material accumulations that can accelerate bearing wear.

2) The arbor shaft is supported by extra capacity, ball bearings. These bearings are lubricated at the time of manufacture and do not require additional servicing when placing the unit in initial service or during their normal service life. During the first few hours of service, lubrication material may seep from the bearings. This should not be a cause for immediate concern.

3) The swivel wheel casters are sealed to minimize the potential for dust contamination. Lubricate the swivel caster wheels with the grease gun. Use sparingly. Excess lubricant will attract the fine grained, powdered materials described in this manual and directly affect bearing service life.

4) Do not apply belt dressing materials to the V-belts for the purpose of minimizing slippage. These products typically attract foreign material accumulations that can accelerate component wear. Excessive V-belt slippage can be eliminated with proper V-belt tension and alignment.

ENGINE SERVICE.

RCC130H Crack Saw.

Consult the material supplied by the engine manufacturer for specific service and maintenance information regarding:

- 1) Muffler
- 2) Spark Plug
- 3) Air Filter System
- 4) Carburetor Adjustment
- 5) Ignition System
- 6) Short and Long Term Storage
- 7) Maximum Governor Speed
- 8) Emission Standards

Keep this information stored with the Operator's Manual for the Crack Saw so it will always be available for use when the engine requires service or maintenance. A properly maintained engine will add considerably to the service life and overall productivity of the Crack Saw.

Troubleshooting

ENGINE FAILS TO START

Ignition switch in OFF or cut off position. Place switch in the ON position or move throttle control lever to the ignition operational position. Incorrect carburetor/fuel ignition system adjustment. See **Service** section.

Air filter blocked. See **Service** section.

Ignition wire to spark plug loose or disconnected. Reconnect.

Fuel supply exhausted. Refill the fuel tank.

ENGINE LOSES POWER

Incorrect carburetor/fuel injection adjustment. See **Service** section.

Water in fuel supply. Drain and replace fuel.

Excessive carbon accumulation in combustion chamber. See **Service** section.

Fuel tank breather vent closed (if so equipped). Open vent.

Air filter system blocked. See **Service** section.

OPERATIONAL PROBLEMS.

! DANGER

ALWAYS UTILIZE DIAMOND BLADES IN COMPLIANCE WITH ANSI B7.1, ANSI B7.5 AND/OR LATEST REVISION(S) AND APPLICABLE OSHA REGULATIONS. IMPROPER USE OF DIAMOND BLADES CAN RESULT IN PROPERTY DAMAGE AND/OR PERSONAL INJURY.

Copies of ANSI B7.1 and B7.5 for review and education purposes can be obtained from the American National Standards Institute, 1430 Broadway, New York, NY, 10018. Copies of the applicable OSHA regulations governing the use of powered equipment and diamond blades can be obtained from your nearest OSHA office.

DIAMOND SEGMENT LOSS

a) The Crack Saw is not being held firmly by the operator, causing the blade to twist or jam in the work surface. Hold the Crack Saw firmly.

b) Overheating due to inadequate supply of coolant (air or water). This is usually accompanied by discolorations which appear on the blade blank in the area of the segment loss. If wet sawing, provide adequate water flow to both sides of the blade. Determine that no water line blockage exists. If dry sawing, periodically allow the blade to run out of the saw cut for up to 20 seconds for every minute of sawing. This will allow the blade to properly cool before resuming sawing operations .

c) The blade blank wears thin as a result of undercutting by abrasive fines generated by the sawing process. The blade blank wears to a knife edge which weakens the blank and causes a segment to separate. If the fines are highly abrasive, wear resistant blanks should be utilized to retard the undercutting phenomenon. Inspect the blades periodically during usage for this occurrence. If wet cutting, allow for ample water to flush the fines out of the saw cut.

d) Improper clamping action by the arbor shaft hub body and hub flange causes the blade to flutter in the cut or fail to support the blade in proper alignment. Always clean foreign material accumulations from the flange surfaces. Replace the flanges if they become bent or deformed with factory approved replacement parts only.

e) The blade can be too hard for the specific material being sawed, causing excessive dullness and segment separation due to impact loads and/or fatigue. This occurrence can also be the direct cause of frictional heat which can melt the brazing filler material that secures the segments to the blade blank. Use a proper blade specification for the material being cut. Match the segment matrix composition to the specific aggregate material being sawed.

f) The blade rotation while sawing is out of round (not concentric), resulting in direct impulse loads being applied to the segments. Replace worn machine components including bearings and arbor shaft.

g) Improper blade rotational speed which produces excessive pressure on the segments and subsequent failure of the brazed/welded joint, blade blank or segment itself. Determine that the blade is being operated within the industry recommended RPM speed range. Engine RPM should be checked

periodically with an electronic tachometer to ensure proper operational speed for the blade.

UNEVEN SEGMENT WEAR

a) If wet sawing, insufficient water flow to one side of the blade which effectively reduces the side clearance. Flush the water system. Determine that water is being adequately and equally distributed to both sides of the blade.

b) Worn machine components. Determine that machine components, including bearings, belts and the arbor shaft are not excessively worn and requiring replacement. Determine that the engine runs smoothly to prevent harmonic vibrations which can result in the blade impacting the work surface with impulse type loads.

c) Saw head is misaligned. Periodically check saw head for squareness in both vertical and horizontal planes.

SEGMENT CRACKS

a) Blade matrix composition is too hard for the material being sawed. Utilize a blade with a softer matrix composition.

SHORT BLADE SERVICE LIFE

a) Utilizing the improper blade for sawing a specific material. Avoid the use of a general purpose blade for sawing a single specific material. General purpose blades are intended to saw a wide range of materials. Since it is unlikely that the machine will saw the proper amount of both hard and soft materials proportionately at all times, this type of blade is not the most economical method of sawing. Use a blade with the matrix composition designed specifically for the material and aggregate being sawed.

b) While wet sawing, improper water flow is being delivered to both sides of the blade. Determine that all water hoses are clean and free of any internal blockage. Approximately two to five gallons of water per minute are required to properly cool a blade.

c) Worn machine components. Determine that machine components including bearings, belts and the arbor shaft are not excessively worn and requiring replacement. Determine that the engine runs smoothly to prevent harmonic vibrations which can result in the blade impacting the work surface with impulse type loads.

d) Loss of power, resulting from improper engine RPM speed, electric motor voltage or loose V-belts. See **Service** section.

BLADE WILL NOT CUT

a) Blade matrix composition is too hard for the material being sawed. Utilize a blade with a softer matrix composition.

b) Blade has become dull, probably as a result a hard matrix composition being utilized to saw a hard material. Dress or sharpen the blade by utilizing it to saw a softer material to expose new diamonds in the segments. If continual dressing is required, it would indicate that the blade matrix composition is too hard for the material being sawed.

c) Failure to initially break in a new blade on a specific material being cut. Allow the blade to sharpen itself on the material to be sawed when first placing it on the Crack Saw. This is the proper method to break in a new blade. Do not force the new blade into a cut as this will generally aggravate the problem.

d) Loss of power, resulting from improper engine RPM speed, electric motor voltage or loose V-belts. See **Service** section.

e) When dry sawing, the blade becomes dull as a result of overheating, allowing the segment rim to "mushroom" or melt. Discontinue usage and contact the diamond blade manufacturer.

BLADE BLANK WARPAGE

a) The blade blank has been overheated. While wet sawing, improper water flow is being delivered to both sides of the blade. Determine that all water hoses are clean and free of any internal blockage.

b) The blade blank has been overheated. While dry sawing, periodically allow the blade to run out of the cut for up to 20 seconds for every minute sawing. This procedure will allow the blade to cool in a few seconds and allow the sawing process to proceed. If the blade has been warped (dark blue color), it may be damaged beyond repair. A blade in this condition should be discontinued from use immediately and properly discarded.

c) The blade blank has been overheated as a result of spinning on the arbor shaft. Check the arbor shaft, hub body and hub flange for excessive wear and/or damage. Properly tighten the arbor shaft nut.

d) Unequal flange clamping forces. The hub body flange and hub flange must be of the same, identical diameter. Always replace any questionable component with a factory replacement part only.

BLADE WOBBLES

a) Worn machine components. Determine that machine components including bearings, belts and the arbor shaft are not excessively worn and requiring replacement. Determine that the engine runs smoothly to prevent harmonic vibrations which can result in the blade impacting the work surface with impulse type loads. Inspect the hub body flange and hub flange for material accumulations. Keep all surfaces clean and flat. Always replace any questionable component with a factory replacement part only.

b) Improper blade operating speed. Determine that the blade is being operated within the industry recommended RPM speed range. Engine RPM should be checked periodically with an electronic tachometer to ensure proper operational speed for the blade.

c) Blade is bent. Contact the blade manufacturer. A blade in this condition should be discontinued from use immediately and properly discarded.

BLADE BLANK DAMAGE

a) Cracks in the blade blank. Contact the blade manufacturer. A blade in this condition should be discontinued from use immediately and properly discarded.

b) Blade blank undercutting. Highly abrasive fines are being generated during the sawing process, resulting in an abrading or wearing away of the blank faster than the diamond segments. Blades manufactured with wear resistant blanks can be specified from many manufacturers. Wear resistant blanks may not be the proper solution to the problem. Any blade experiencing this type of wear problem should be carefully inspected in shorter intervals to determine proper structural integrity.

BLADE NOT ROTATING WITH PROPER CONCENTRICITY

a) Worn machine components. Determine that machine components including bearings, belts and the arbor shaft are not excessively worn and requiring replacement. Determine that the engine runs smoothly to prevent harmonic vibrations which can result in the blade impacting the work surface with impulse type loads.

b) Blade arbor hole damaged from previous usage. A blade in this condition should be discontinued from use immediately and properly discarded.

c) Blade is spinning on the arbor shaft. Check the arbor shaft, hub body and hub flange for excessive wear and/or damage. Worn, bent or dirty hub body flange and hub flange will not allow the blade to be properly tightened on the arbor shaft. Properly tighten the arbor shaft nut. Replace any questionable component with a factory replacement part only.

d) Blade matrix composition is too hard for the material being sawed. Utilize a blade with a softer matrix composition.

e) Blade is not properly mounted to the Crack Saw. Determine that the blade is mounted to the proper diameter spindle before tightening the arbor shaft nut. Never depend on the drive pin of the arbor hub to actually drive the blade. The drive pin is simply a safety device to prevent the blade from spinning on the arbor shaft should the nut become loose.

Improper lubrication. See LUBRICATION REQUIREMENTS.

UNEVEN SAWING ACTION

Excessive material build-up on the caster wheel face surface. Remove the material.

Excessive caster wheel bearing wear. Replace the caster wheel.

Excessive axle wear. Replace axle.

ACCELERATED V-BELT WEAR

Misaligned and/or improperly tensioned pulleys. Readjust pulleys and V-belt. See **Service** section.

Worn pulleys. Replace pulleys as required. See INSTALLING A REPLACEMENT V-BELT OR PULLEY.

Improper V-belt. Replace with a name brand BX34 series V-belt. Never replace a single belt. Always replace both V-belts at the same time in matched sets.

ACCELERATED BEARING WEAR AND/OR FAILURE

Misaligned and/or improperly tensioned pulleys. readjust pulleys and V-belts. See **Service** section.

Bent arbor shaft. Replace arbor shaft.

Storage

Proper procedure for long term storage of the Crack Saw will protect it against the effects of corrosion and damage. If the Crack Saw is not to be operated for a period of 30 days or more, proceed to store as follows:

1) Follow Clean all accumulated foreign material from the Crack Saw utilizing an appropriate safety solvent.

! CAUTION

Observe all applicable safety precautions for the solvent.

2) Follow the procedure as outlined in the material supplied by the engine manufacturer describing long term storage for the engine.

3) Check all visible parts for wear, breakage or damage. Order any part not required to make the necessary repair. This will avoid a needless delay when operating the Crack Saw at next use.

4) Apply a dry film lubricant to all exposed metal components to prevent rust.

5) Store the Crack Saw inside. If the Crack Saw must be stored outside, protect it with a suitable covering.

Specifications

FRAME.

STRUCTURE.....	Unitized, Welded Steel Plate
DRIVE REDUCTION SYSTEM	BX34 Series Belt/Pulley/Spur Gear Transmission.
OVERALL MACHINE WIDTH.....	27-1/2 inches (699 mm)
OVERALL MACHINE LENGTH.....	52 inches (1,321 mm)
OPERATOR HANDLE HEIGHT	43 inches (1,092 mm)
BLADE ROTATION ORIENTATION	Downcut as Viewed by the Operator
VACUUM CLEANER CONNECTION.....	3-inch (76 mm) Diameter.

GENERAL.

DIAMOND BLADE DIAMETER 8 inches (203 mm) nominal ONLY. Do not utilize diamond blades or other attachments of different diameter other than that approved for use with the Crack Saw by the manufacturer.

AVAILABLE DIAMETER BLADE SAWING WIDTHS..... 1/4 inch (6.4 mm), 3/8 inch (9.5 mm), 1/2 inch (12.7 mm)

SPECIAL APPLICATION BLADE SAWING WIDTHS. CONSULT THE CUSTOMER SERVICE DEPARTMENT OF STOW FOR ADDITIONAL INFORMATION. 3/4 inch (19 mm), 1 inch (25.4 mm)

MAXIMUM STRAIGHT LINE SAWING DEPTH..... 1-1/2 inches (38 mm)

ARBOR SHAFT DIAMETER

1-inch (25 mm).

RCC130H BASIC WEIGHT

290 lbs (132 kg).

HONDA GX390K1QWT2 ENGINE 13 hp (97 kw) nominal, industrial quality, 4 cycle engine, 3450 RPM nominal maximum governed speed.

EXPLANATION OF CODE IN REMARKS COLUMN

How to read the marks and remarks used in this parts book.

Section 1: Items Found In the “Remarks” Column

Serial Numbers-Where indicated, this indicates a serial number range (inclusive) where a particular part is used.

Model Number-Where indicated, this shows that the corresponding part is utilized only with this specific model number or model number variant.

Section 2: Items Found In the “Remarks” Column

Serial Numbers-Where indicated, this indicates a serial number range (inclusive) where a particular part is used.

Model Number-Where indicated, this shows that the corresponding part is utilized only with this specific model number or model number variant.

Items Found In the “Items Number” Column

All parts with same symbol in the number column, \$, #, +, %, or >, belong to the same assembly or kit.

RCC130H CRACK SAW 1 TO 3 UNITS ***Gasoline Engine Model Honda GX390***

Qty.	P/N	Description
6.....	29022-014.....	V-BELT
3.....	17210ZE3505	ELEMENT AIR CLEANER
3.....	9807956846	SPARK PLUG
1.....	17620ZH7023	CAP, FUEL TANK
1.....	28462ZV7003	ROPE, RECOIL
1.....	CS8-0350.....	SWITCH ASSY, SHUT-OFF

OPERATOR HANDLE ASSY.

OPERATOR HANDLE ASSY.

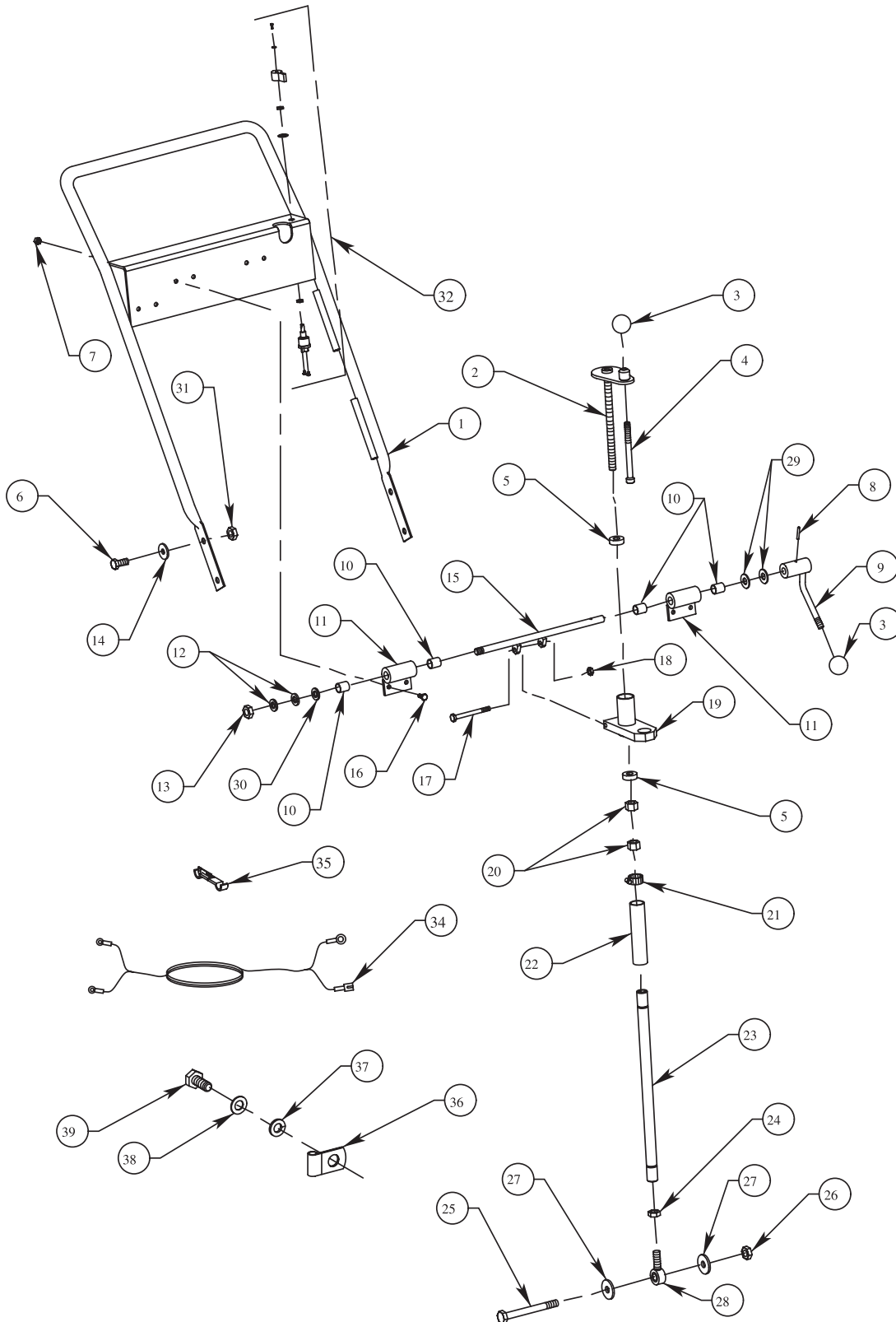

OPERATOR HANDLE ASSY.

OPERATOR HANDLE ASSY.

<u>NO.</u>	<u>PART NO.</u>	<u>PART NAME</u>	<u>QTY.</u>	<u>REMARKS</u>
1	29022-017	HANDLE, OPERATOR	1	
2	29022-018	CRANK SCREW	1	
3	29020-030	KNOB	1	
4	29020-031	SCREW, HEIGHT ADJUSTMENT	1	
5	29022-019	BEARING	2	
6	06503-012	SCREW, CAP 1/2-13 UNC X 1-1/2" PLATED GRD 5	4	
7	08233-006	NUT, NYLOC 3/8"-16 UNC, PLATED	4	
8	07594-024	PIN, ROLL 3/16" X 1-1/2"	1	
9	29022-020	LEVER	1	
10	29022-021	BUSHING	4	
11	29022-022	HINGE W/BELLEVILLE	2	
12	29022-023	WASHER, BELLEVILLE 5/8"	2	
13	08297-010	NUT, SELF-LOCKING 5/8-18 UNF, PLATED	1	
14	07030-008	WASHER, FLAT 1/2", PLATED	4	
15	29022-024	SHAFT, OVER CENTER	1	
16	06501-008	SCREW, CAP 3/8-16 UNC X 1, PLATED GRADE 5	4	
17	29022-025	SCREW, CAP 3/8-16 UNC X 3-3/4" STAINLESS	1	
18	07033-006	NUT, 3/8-16 UNC, PLATED	1	
19	29022-026	TUBE, BEARING	1	
20	18982-010	NUT, 5/8-11 UNC, LH PLATED	2	
21	14821-004	CLAMP, HOSE 1-4"	1	
22	29020-034	BOOT, RUBBER	1	
23	29020-035	BARREL, ADJUSTING	1	
24	06922-004	NUT, JAM 5/8-18 UNF, LH PLATED	1	
25	06505-048	SCREW, CAP 5/8-11 UNC X 6" PLATED, GRD 5	1	
26	07033-010	NUT, HEXAGON 5/8-11 UNC, PLATED	1	
27	07030-010	WASHER, FLAT 5/8" PLATED	2	
28	29020-036	ROD END, MALE	1	
29	29022-027	WASHER, PLASTIC	2	
30	29019-013	WASHER, FLAT 5/8" SPECIAL PLATED	1	
31	08233-008	NUT, NYLOC 1/2-13 UNC, PLATED	4	
32	CS8-0350	KILL SWITCH/ CABLE	1	
34	CS8GH-0370	WIRE LOOM, SHUT-OFF	1	
35	CS8-0390	T-TAP, 22-18 GAUGE WIRE	1	
36	CV-0411	CLAMP, PLATED	1	
37	07029-008	WASHER, LOCK 1/4"	1	
38	07030-008	WASHER FLAT 1/4"	1	
39	06499-006	HHCS, 1/4"-20 X 3/4" UNC PLATED GRADE 5	1	

DRIVETRAIN AND ENGINE MOUNTING ASSY.

DRIVETRAIN AND ENGINE MOUNTING ASSY.

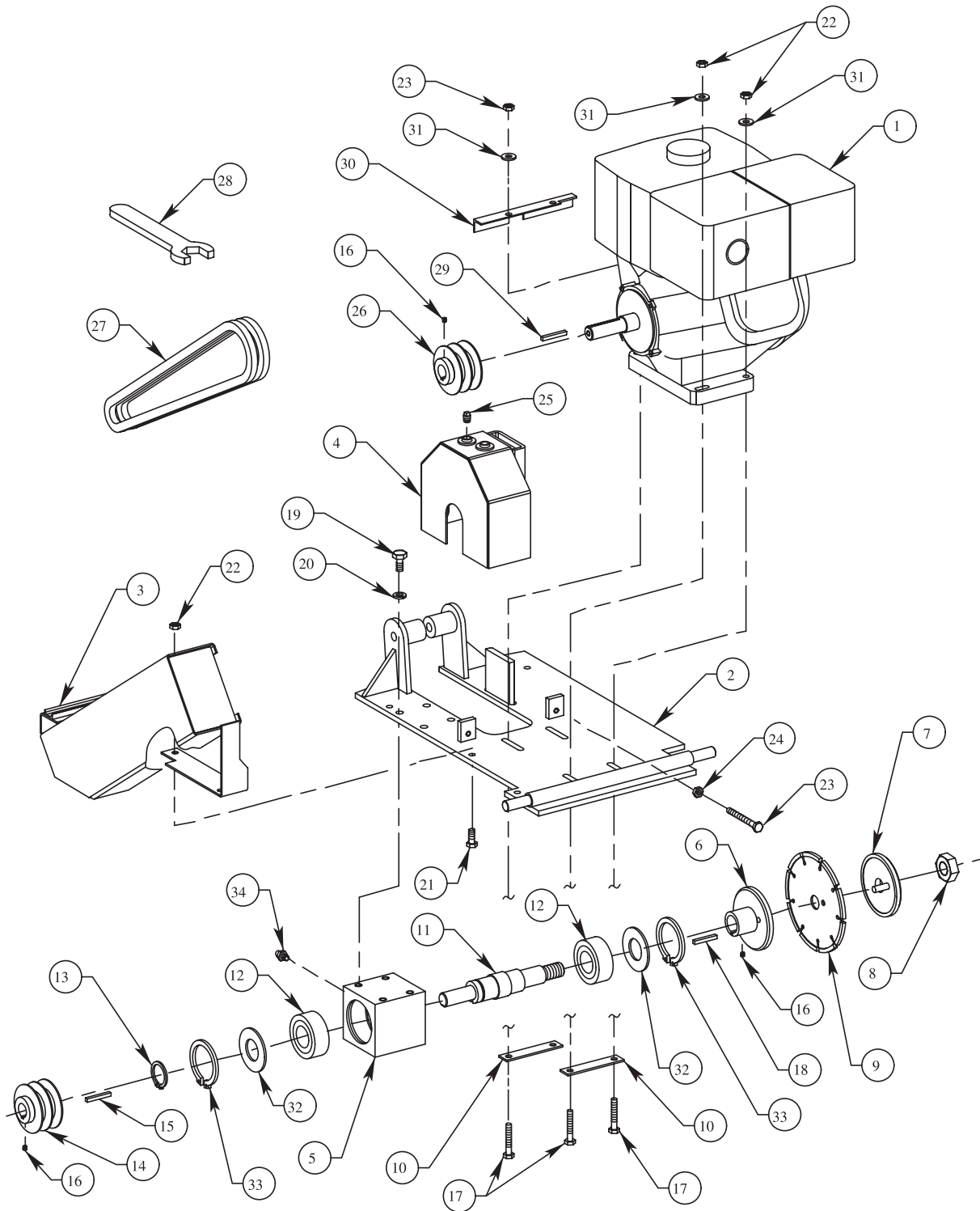

DRIVETRAIN AND ENGINE MOUNTING ASSY.

DRIVETRAIN AND ENGINE MOUNTING ASSY.

NO.	PART NO.	PART NAME	QTY.	REMARKS
1	15103	ENGINE, HONDA 13.0 H.P., GX390K1QXC9	1	
2	29022-005	PLATE, ENGINE MOUNT	1	
3	29022-006	GUARD, BELT	1	
4	29022-007	GUARD, BLADE	1	
5	29022-008	BLOCK, BEARING	1	
6	29022-009	BODY, HUB	1	
7	29022-010	PLATE	1	
8	23308-016	NUT, 1-14 UNF, LH THREAD PLATED	1	
9		EIGHT INCH DIAMETER DIAMOND BLADE	1CONTACT
	DIAMONDBACK
	BLADE SALES
10	29022-011	BRACKET, ENGINE MOUNT	2	
11	29022-012	SHAFT, ARBOR	1	
12	29020-016	BEARING, SEALED 5208-2RS	2	
13	29020-011	RING, SNAP	1	
14	80000-006	PULLEY, ARBOR SHAFT	1	
15	10057-019	KEY, SQUARE 1/4" X 1/4" X 2"	1	
16	07897-004	SCREW, SET CUP POINT 1/4"-20 UNC X 1/4"	4	
17	06501-020	SCREW, CAP 3/8-16 UNC X 2-1/2", PLATED GRADE 5	4	
18	10057-032	KEY, SQUARE 1/4" X 1/4" X 1-1/2"	1	
19	06503-010	SCREW, CAP 1/2-13 UNC X 1-1/4" PLATED GRADE 5	4	
20	07030-008	WASHER, LOCK 1/2", PLATED	4	
21	06501-010	SCREW, CAP 3/8-16 UNC X 1-1/4, PLATED GRADE 5	3	
22	08233-006	NUT, NYLOC 3/8-16 UNC, PLATED	7	
23	29018-025	SCREW, CAP 3/8-16 UNC X 3-1/2" FULL THD.	2	
24	07033-006	NUT, 3/8-16 UNC, PLATED	2	
25	29020-009	PLUG, PIPE 1/4" NPTF SQUARE	2	
26	29022-013	PULLEY, ENGINE	1	
27	29022-014	V-BELT BX34	2	
28	29022-015	WRENCH 1-1/2"	1	
29	29018-024	KEY, SQUARE 1/4" X 1/4" X 2-1/2"	1	
30	29022-016	PLATE, THRUST V-BELT TENSION	1	
31	07030-006	WASHER, FLAT 3/8", PLATED	4	
32	TBD			
33	TBD			
34	TBD			

FRAME ASSY

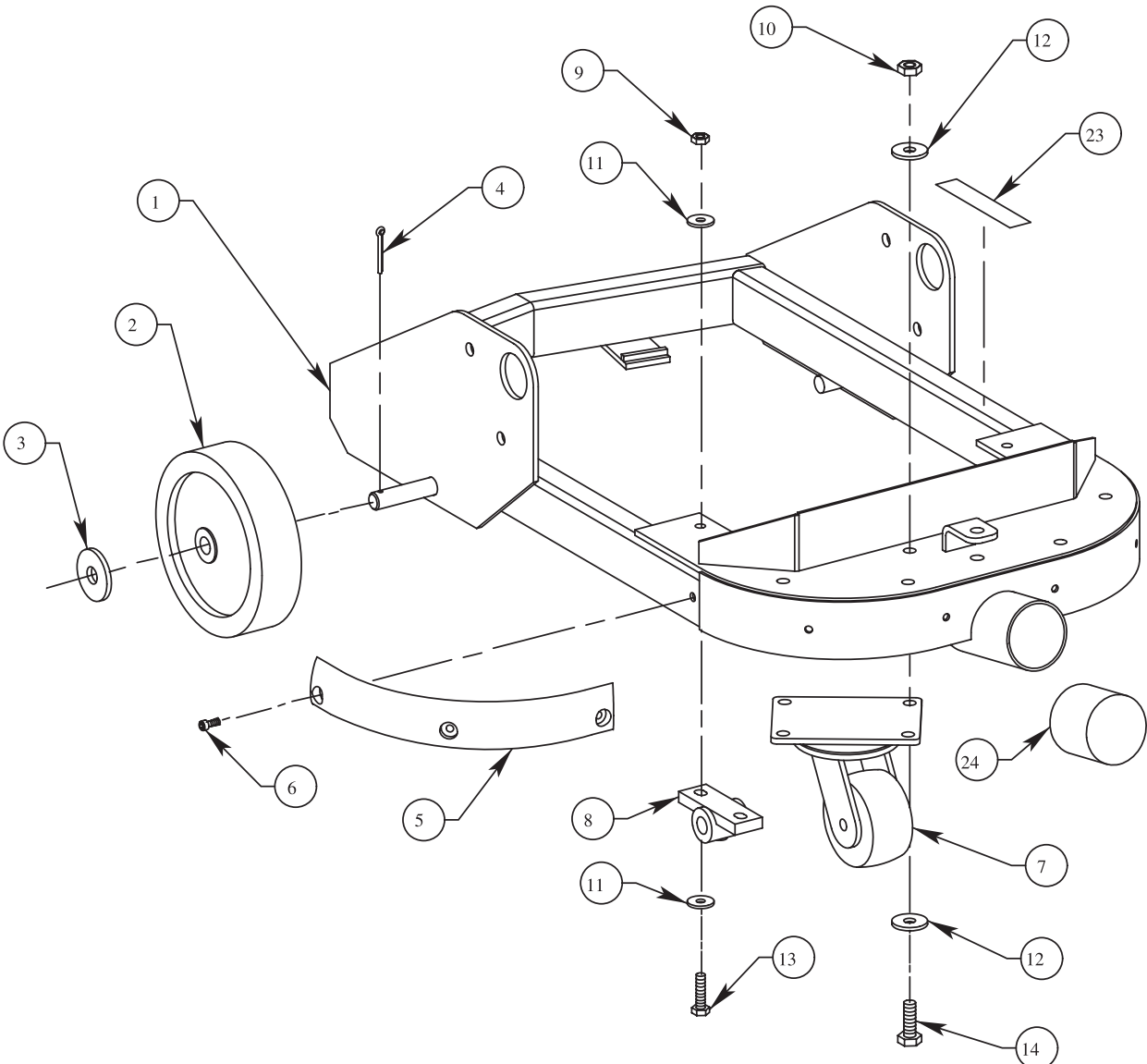

FRAME ASSY

<u>NO.</u>	<u>PART NO.</u>	<u>PART NAME</u>	<u>QTY.</u>	<u>REMARKS</u>
1	29022-001	FRAME, MAIN	1	
2	29018-046	WHEEL	2	
3	07030-012	WASHER, FLAT 3/4" PLATED	2	
4	07028-069	PIN, COTTER 3/16" X 2 PLATED	2	
5	29022-002	BUMPER, RUBBER	2	
6	08696-010	SCREW, CAP COUNTERSUNK 1/4-20 UNC X 5/8"	6	
7	29022-003	WHEEL, CASTER	2	
8	29022-004	BEARING, PILLOW BLOCK	2	
9	08233-006	NUT, HEXAGON NYLOC 3/8-16 UNC, PLATED	4	
10	08233-008	NUT, HEXAGON NYLOC 1/2-13 UNC, PLATED	8	
11	07030-006	WASHER, FLAT 3/8", PLATED	4	
12	07030-008	WASHER, FLAT 1/2" PLATED	8	
13	06501-012	SCREW, CAP 3/8-16 UNC X 1-1/2", PLATED	4	
14	06503-012	SCREW, CAP 1/2-13 UNC X 1-3/4" PLATED GRD 5	8	
23	29022-036	PAD, NON SLIP	1	
24	29020-010	CAP, DUST COVER	1	

DUST VACUUM PORT ASSY.

DUST/VACUUM PORT ASSY

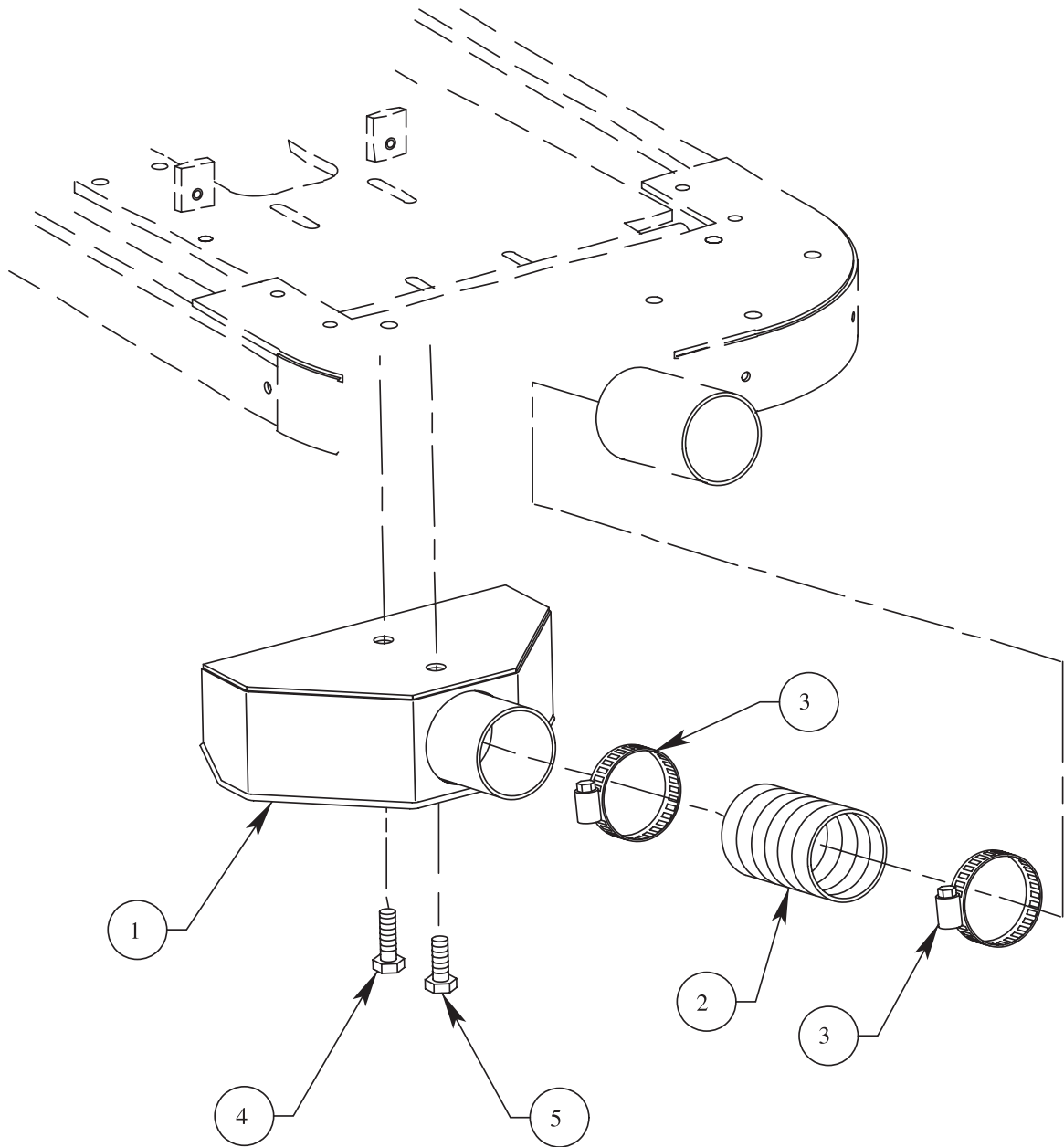

DUST VACUUM PORT ASSY.

DUST/VACUUM PORT ASSY

<u>NO.</u>	<u>PART NO.</u>	<u>PART NAME</u>	<u>QTY.</u>	<u>REMARKS</u>
1	29022-028	SHROUD, VACUUM	1	
2	29022-029	HOSE, VACUUM	1	
3	14821-010	CLAMP, HOSE 3"	2	
4	06503-012	SCREW, CAP ½-13 UNC X 1-1/4" PLATED GRADE 5	1	
5	06503-010	SCREW, CAP ½-13 UNC X 1" PLATED GRADE 5	1	

WET CUTTING KIT ASSY.

WET CUTTING KIT ASSY

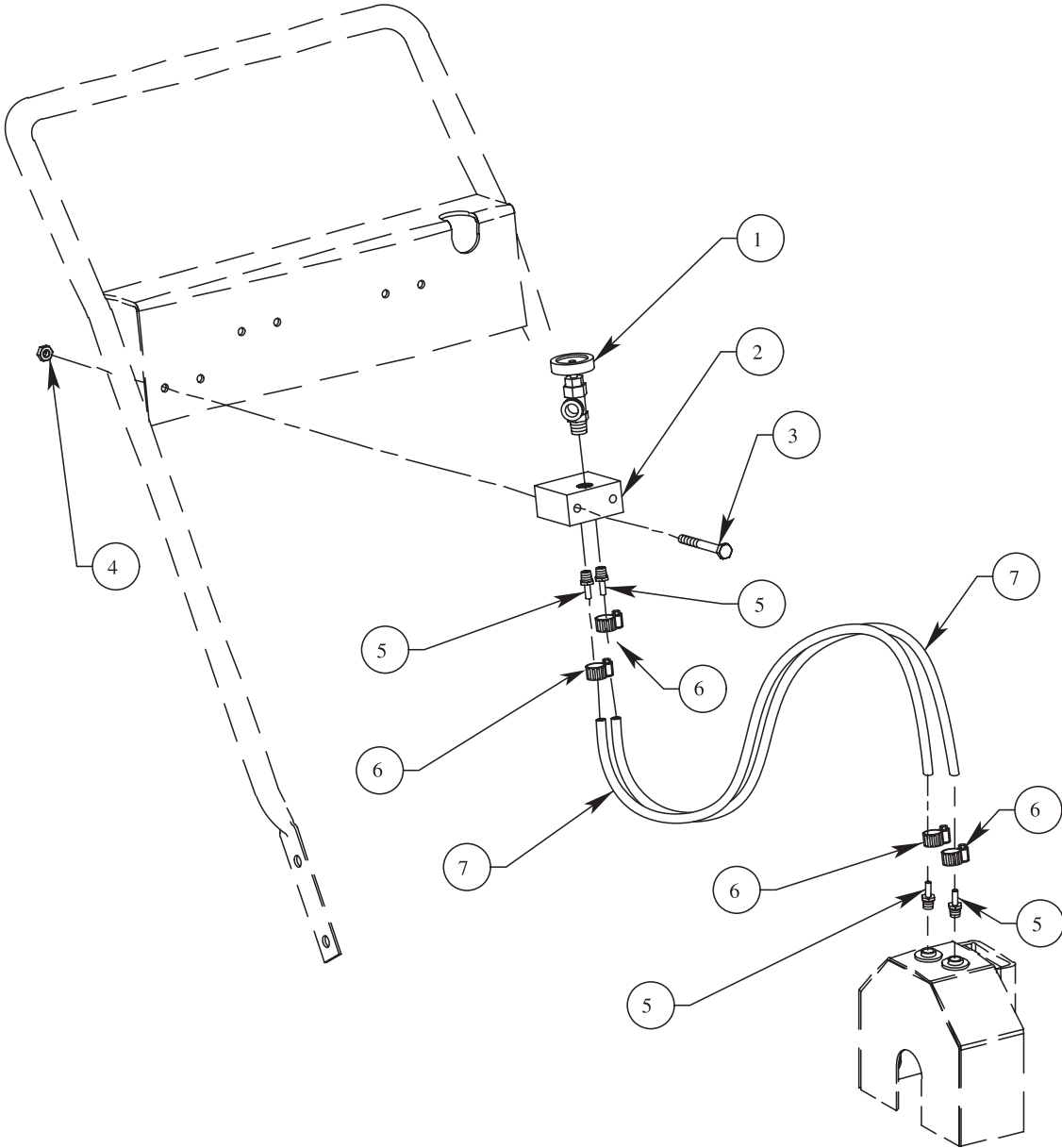

WET CUTTING KIT ASSY.

WET CUTTING KIT ASSY

<u>NO.</u>	<u>PART NO.</u>	<u>PART NAME</u>	<u>QTY.</u>	<u>REMARKS</u>
1	29020-007	VALVE	1	
2	29022-030	BLOCK, MANIFOLD	1	
3	06500-026	SCREW, CAP 3/8-16 UNC X 3-1/2, PLATED GRD 5	2	
4	08233-005	NUT, HEXAGON NYLOC 3/8-16 UNC, PLATED	2	
5	29022-031	ADAPTER, HOSE 1/4" NPTF 3/8" BARB	4	
6	14821-001	CLAMP, HOSE 5/8"	4	
7	29022-032	HOSE WATER 3/8"	2	

DECALS

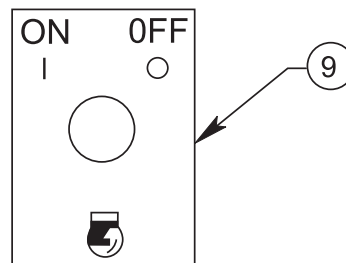
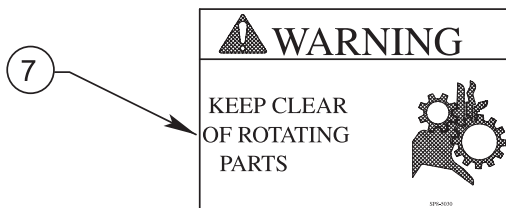
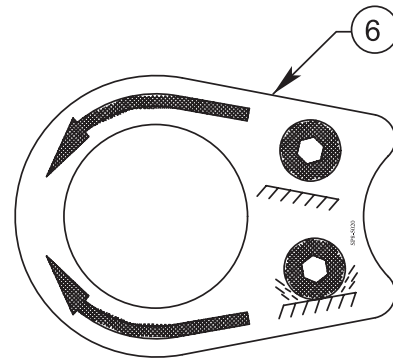
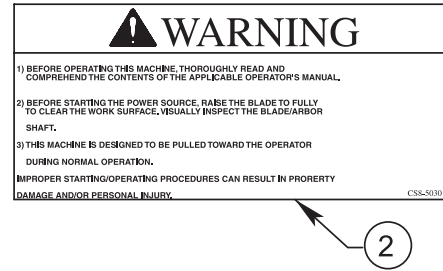

DECALS

<u>NO.</u>	<u>PART NO.</u>	<u>PART NAME</u>	<u>QTY.</u>	<u>REMARKS</u>
1	29020-045	DECAL, WARNING	1	
2	29022-033	DECAL, OPERATION	1	
3	29020-048	DECAL, WARNING	2	
4	29022-035	DECAL, WARNING	2	
5	29022-034	DECAL, WARNING	2	
6	29020-047	DECAL, DEPTH CONTROL	1	
7	29020-049	DECAL, WARNING	1	
8	DCLSDP	DECAL, STOW (LARGE)	1	
9	CS8-5070	DECAL, SHUT-OFF	1	



Terms and Conditions of Sale STOW Construction Equipment

PAYMENT TERMS

Terms of payment for unit sales are 2% 15 days net 30 days from date of invoice unless otherwise specifically stated on our invoice. Parts invoices have terms of net 10 days.

Minimum parts billing is \$15.00 net.

Applicable discounts will be computed on merchandise value only. Late charges will be assessed at prevailing rates. Cash discounts cannot be taken on current billings if any previously billed amounts are past due.

FREIGHT POLICY

Freight policy is established to offer customers every advantage possible. Due to bulk freight ratings on some equipment and other shipping considerations, freight policies differ by equipment type. Actual back freight may be charged for shipments originating from other than specified FOB warehouses.

See Freight Policy for details.

All STOW domestic sales are FOB nearest available designated MQ/STOW warehouse. Export orders are ex-works factory located in Carson, CA or Boise, ID.

Additions to orders already shipped cannot be accepted for freight minimums.

Should STOW elect to make partial shipments of an order originally complying with the "freight allowed" requirements, transportation charges will be absorbed by STOW on any subsequent shipment applying to that order.

All other orders will be shipped collect or prepaid with charges added to the invoice. STOW's responsibility ceases when a signed manifest has been obtained from the carrier, and any claim for shortage or damage must be settled between the consignee and the carrier.

Parts: FOB Carson, California or Boise, Idaho. **See Freight Policy for details and additional discounts.**

DROP SHIPMENTS

STOW reserves the right to refuse Drop Shipments outside the normal service area of the purchasing dealer.

FIELD WAREHOUSES

Field Warehouses are currently located in California, Georgia, Idaho, Iowa, and New Jersey

SPECIAL EXPEDITING SERVICE

The higher of a \$35.00 surcharge or actual costs will be added to the invoice for special handling, including bus shipments, or in cases where STOW personnel must personally deliver the equipment or parts to the carrier.

RETURNED GOODS POLICY

Return shipments may be accepted and credit allowed, subject to the following provisions.

1. A Returned Material Authorization (RMA) must be approved by STOW prior to shipment. Approvals for returned goods must be with just cause and are at the sole discretion of STOW. A copy of the Authorization must accompany the shipment to the designated Warehouse.
2. Parts being returned must be listed as currently supplied on the current parts list.
3. Parts must be in new and resalable condition in the original package, with part numbers clearly marked.
4. Units and accessories must be current models in the latest price list and in new and resalable condition.
5. Special order items are not returnable for credit.
6. Credit on returned parts and units will be issued at actual dealer net price at time of purchase less 15% restocking charge.
7. All returned shipments are to be made to the STOW designated receiving point, freight prepaid at the sender's expense.

The sender will be notified of any material received that does not meet the above provisions. Such material will be held for 30 days from notification pending instructions. If a reply is not received within 30 days, the material will be returned to the sender at his expense with no credit issued.

PRICING, REBATES AND SPECIFICATIONS

Every effort will be made to provide adequate notice of changes; however, prices and equipment specifications are subject to change without notice.

Price changes are effective on a specific date and all orders received on or after that date will be billed at the revised price.

Rebates for price reductions and added charges for price increases will not be made for stock in dealer inventory at the time of a price change.

STOW reserves the right to quote and sell direct to Government agencies and to Original Equipment Manufacturer accounts who use our products as integral parts of their own products.

LIMITATION OF SELLER'S LIABILITY

STOW shall not be liable hereunder for damages in excess of the purchase price of the item with respect to which damages are claimed and in no event shall STOW be liable for loss of profit or good will or for any other special, consequential or incidental damages.

LIMITATION OF WARRANTIES

There are no warranties, express or implied, made by STOW hereunder on Products manufactured or distributed by it except the warranty against defects in material and workmanship on new Products to the original purchaser, as set forth in the STOW New Product Limited Warranty.

OPERATION AND PARTS MANUAL

HERE'S HOW TO GET HELP

PLEASE HAVE THE MODEL AND SERIAL NUMBER ON-HAND WHEN CALLING

PARTS DEPARTMENT

800-427-1244 or 310-537-3700

FAX: 800-672-7877 or 310-637-3284

SERVICE DEPARTMENT

800-421-1244

FAX: 310-537-4259

TECHNICAL ASSISTANCE

800-478-1244

FAX: 310-631-5032

WARRANTY DEPARTMENT

888-661-4279, or 310-661-4279

FAX: 310-537-1173



STOW CONSTRUCTION EQUIPMENT

A DIVISION OF MULTIQUIP INC.

POST OFFICE BOX 6254

CARSON, CA 90749

310-537-3700 • 888-252-STOW [888-252-7869]

FAX: 310-537-1986 • FAX: 800-556-1986

E-MAIL: stow@multiquip.com • WWW: stowmfg.com

PARTS DEPARTMENT:

800-427-1244

FAX: 800-672-7877

SERVICE DEPARTMENT/TECHNICAL ASSISTANCE:

800-478-1244

FAX: 310-631-5032